

2016/2017

HYDRAULIC RESCUE SYSTEMS



E FORCE 2

WEBER RESCUE
SYSTEMS

www.weber-rescue.com

WITH NEW TECHNOLOGIES INTO THE FUTURE

New vehicle technologies and continuously optimised safety systems in vehicles improve the protection of the occupants. However, they are always presenting new challenges for the emergency services. WEBER RESCUE SYSTEMS provides for this trend by continuously developing high-performance rescue systems.

We have the right rescue equipment for practically any scenario. In recent years, our innovations have been focused around flexible, battery-operated tools in the E-FORCE series. However, our standard range has also been advanced with new generations of cutters and blades (RSU PLUS), new spreaders (AS and BS spreaders) and power units (E/V 70 W).

We offer a comprehensive range of tried-and-tested solutions, now complemented by additional equipment such as the STAB-FAST ALU, PAT-STAB and PAT-SAFE.

A further component of our success is our worldwide training and education programmes for emergency service personnel. An example of this is our RESCUE DAYS events, which are now held in multiple countries (Austria, Brazil, Japan, etc.) and at which thousands of fire service and rescue personnel have already been trained.

You can get the best overview of the many advantages of our systems during a personal product presentation at your own location, where you can discover for yourself what lies behind the experience of WEBER RESCUE products.

You can find more interesting information on our products and services at www.weber-rescue.com.

The WEBER RESCUE Sales Team

WEBERRESCUE
SYSTEMS

CONTENT

| | |
|-------------------------------|----|
| NEW TECHNOLOGIES | 4 |
| SPREADERS | 6 |
| CUTTERS | 10 |
| COMBI TOOLS | 16 |
| RESCUE RAMS | 20 |
| POWER UNITS | 24 |
| COMPACT POWER UNITS AND HOSES | 28 |
| E-FORCE 2 BATTERY TOOLS | 34 |
| LIGHT-TOOLS | 42 |
| LIFTING EQUIPMENT | 44 |
| STABILISATION | 48 |
| ACCESSORIES | 54 |
| S'SERIES | 62 |
| TRAINING | 66 |

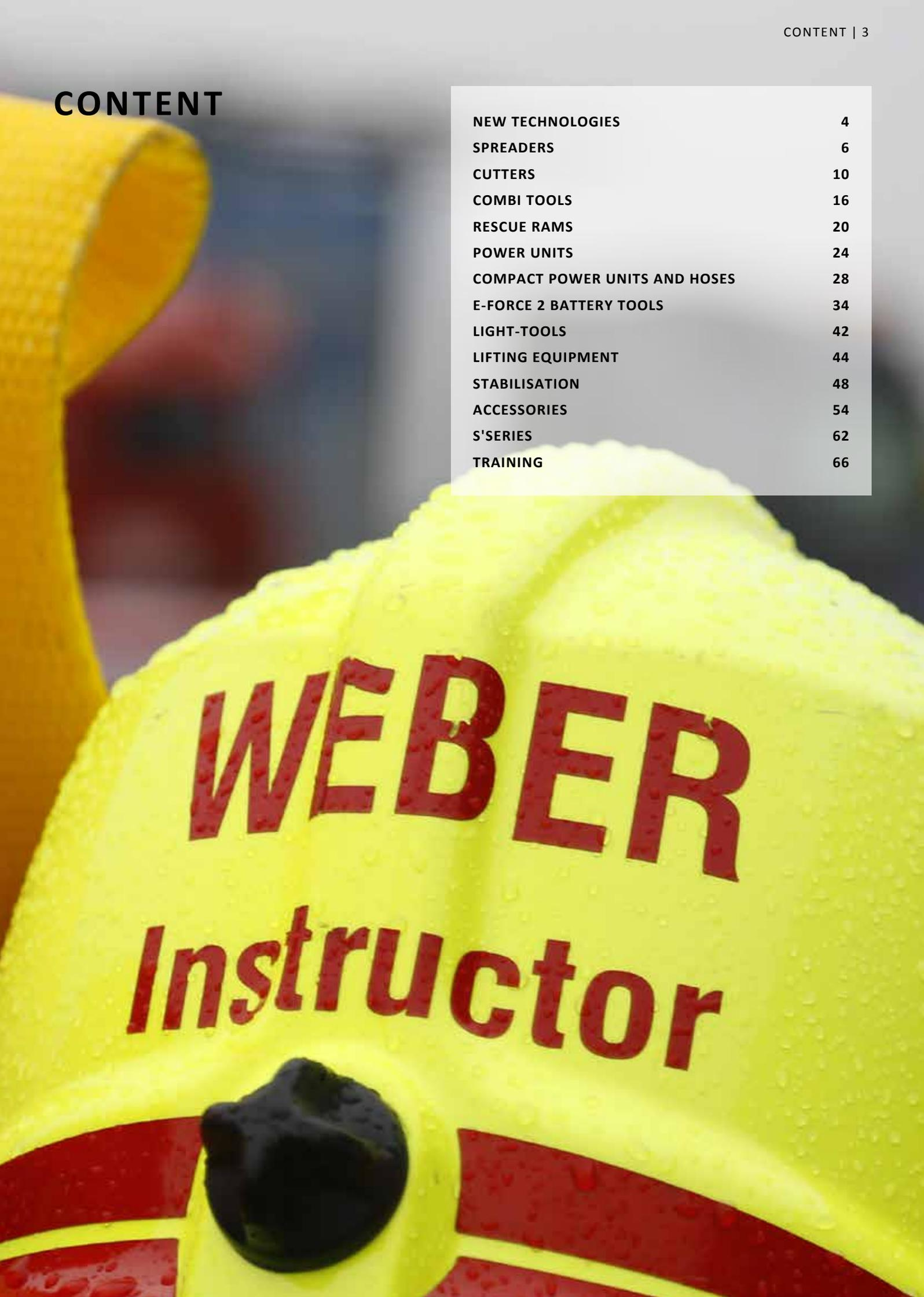

WEBER
Instructor

WEBER RESCUE PRODUCTS WITH THE LATEST TECHNOLOGIES!

| | |
|---|--|
|  PLUS | Changeable inserts made of high strength alloy |
|  COAX | Hose-in-hose-system for better handling |
|  SINGLE | Quick and easy connection of hoses with one movement without unintended release |
|  HANDLE | Rotatable (360°) and detachable handle |
|  CHARGE | Rechargeable Li-Ion batteries for independent operation |
|  XTREME | Xtreme cutting technology for excellent cutting, especially for latest materials |
|  COMPACT | Best capacity on minimum space and low weight |
|  ECO | Removes extra noise and stress by automatic speed control |
|  TURBO-SPEED | Maximum power through double speed „turbo“ operation of one tool |
|  PUSH-CONTROL | Unique WEBER control for fine tuned precision handling |
|  GRIP | Spikes for extra grip |
|  ULTIMATIVE | High-strength, forged blades for hardest applications |
|  PERFORMANCE | Higher working speed by means of more power |
|  EXTENDIBLE | Creates space in the interior |

NEW GENERATION OF CUTTERS

RSU

ULTIMATIVE



| Blades | ULTIMATIVE | others |
|---------------------|------------|--------|
| Cutting performance | +++ | + |
| Stability/ Safety | +++ | + |
| Blade inserts | ✓ | ✗ |
| Weight | 3.6 kg | 3.9 kg |

High-strength, forged lightweight design blades
 Further optimised ULTIMATE blade design for hardest applications
 Adjustable fibre-reinforced handle for perfect handling

THE NEW MOBILITY **E FORCE 2**

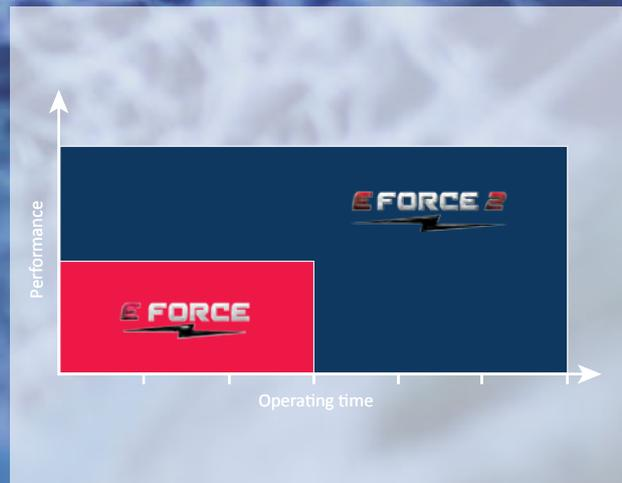

New, efficient and improved drive unit for longer working time at higher speed
 LED lights for better view in the working area
 Long operating time due to 5.0 Ah capacity



USE MEETS BITE

WEBER RESCUE high performance spreaders

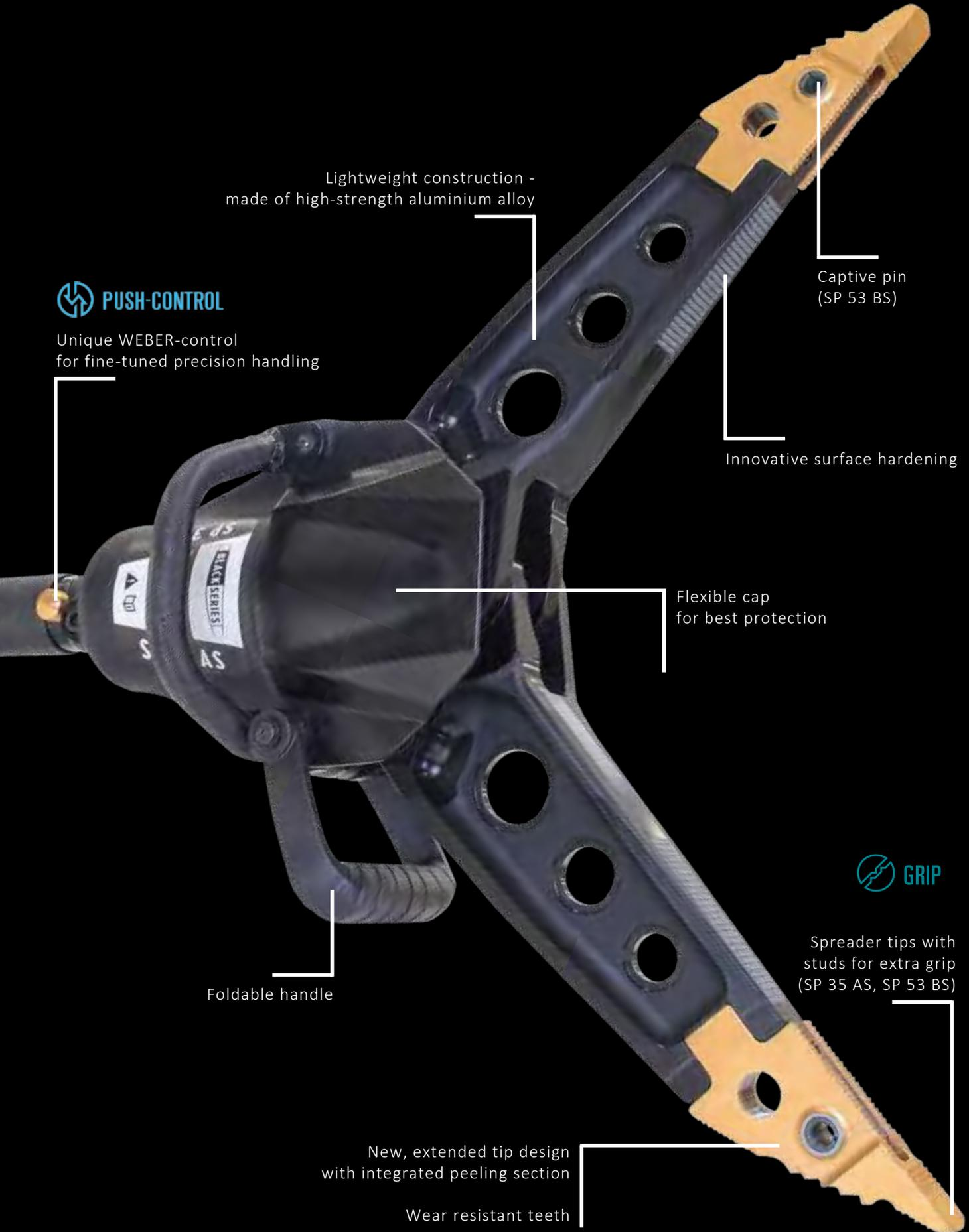

Lightweight construction -
made of high-strength aluminium alloy



Unique WEBER-control
for fine-tuned precision handling

Captive pin
(SP 53 BS)

Innovative surface hardening

Flexible cap
for best protection

Foldable handle



Spreader tips with
studs for extra grip
(SP 35 AS, SP 53 BS)

New, extended tip design
with integrated peeling section

Wear resistant teeth

TIPS AND TRICKS FISH CAN

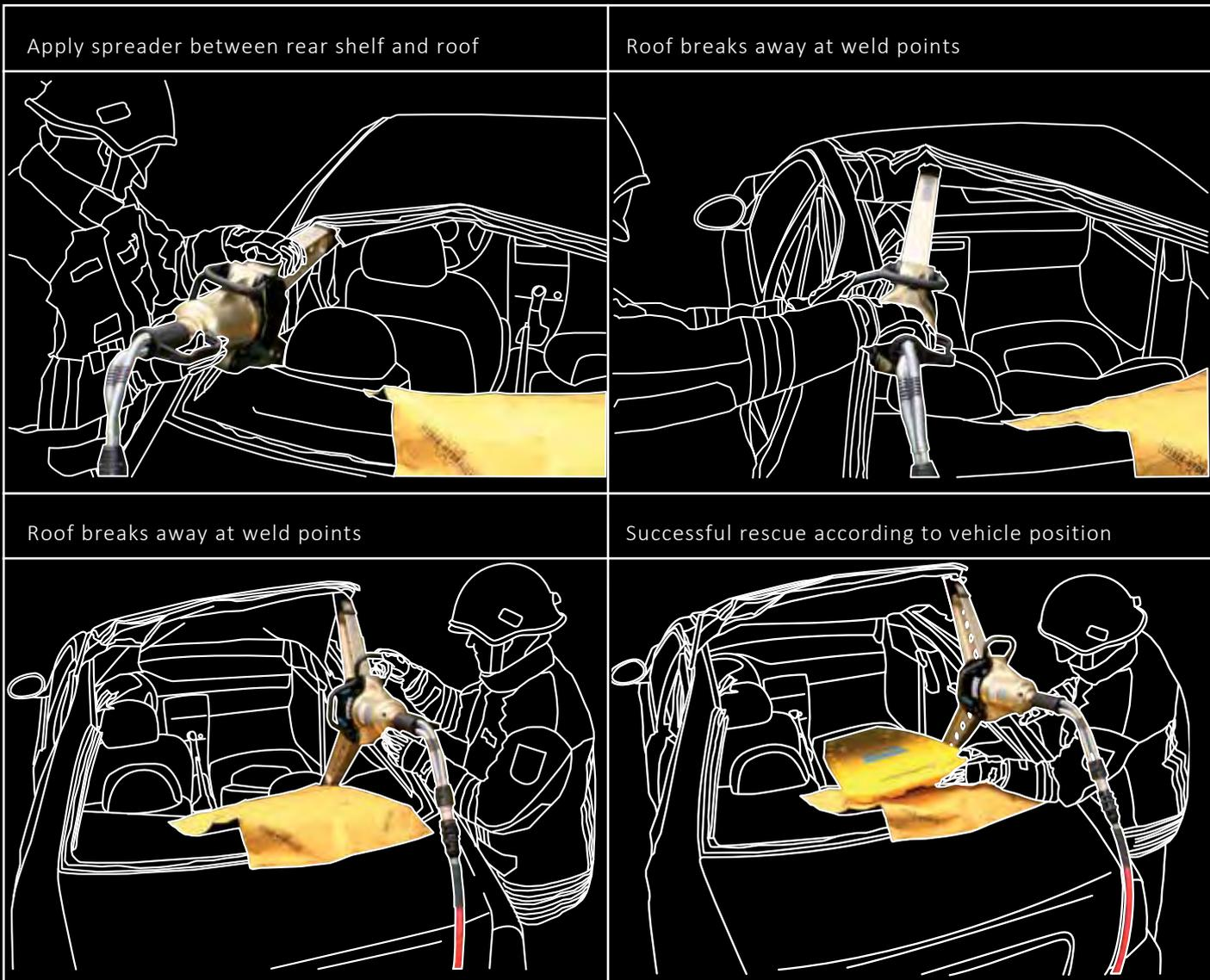

SPREADERS

NEW!

| Type | SP 35 AS | SP 49 | SP 53 BS | SP 60 | SP 80 |
|-----------------------------------|--------------|--------------|--------------|--------------|--------------|
| Spreading force in working range* | 38-171 kN | 54-330 kN | 53-421 kN | 68-492 kN | 90 – 470 kN |
| Closing force* | 76 kN | 101 kN | 100 kN | 110 kN | 102 kN |
| Spreading distance | 600 mm | 710 mm | 800 mm | 810 mm | 620 mm |
| Weight | 14.6 kg | 19.9 kg | 20.3 kg | 24.7 kg | 25.1 kg |
| EN class | AS 35/600-15 | AS 49/710-20 | BS 53/800-20 | BS 63/810-25 | CS 87/600-25 |
| Part no. | 1071373 | 5933633 | 1058125 | 5931479 | 5930758 |

*according to EN 13204 to 700 bar



SP 35 AS

- Lightweight spreader (only 14.6 kg)
- Long arms for extra control and stability
- Large opening of 600 mm
- Captive pin and new tips with studs for extra grip
- Meets AS norm



SP 53 BS

- One of the most lightweight BS spreader (EN norm) worldwide
- Ideally suited to today's automotive materials and demands!
- Large opening of 800 mm
- Captive pin and new tips with studs for extra grip
- Meets BS norm



SP 35 AS



SP 53 BS

TEAM
gold
Power
redefined

SPREADERS



SP 49



SP 60



SP 80

Replacement tips

| | |
|----------|---------|
| SP 35 AS | 1074746 |
| SP 49 | 3885593 |
| SP 53 BS | 1068392 |
| SP 60 | 3878368 |
| SP 80 | 3878376 |

ACCESSORIES

Chain set consisting of:

2 pcs. chain lock, 2 pcs. pulling chain 1.8 m long with hooks. The length of chains can easily be adjusted through a push-button at the chain lock.

| | |
|---------------------------|---------|
| SP 53 BS | 571415 |
| SP 35 AS, SP 49 und SP 60 | 2819139 |
| SP 80 | 2840138 |



THE NEW GENERATION OF CUTTERS



THE ULTIMATIVE Cutter with blade inserts

BLACK SERIES

 **ULTIMATIVE**

Further optimised blade- and cutting edge design for hardest applications

Unique WEBER-control for fine-tuned precision handling

 **PUSH-CONTROL**

Rotatable and detachable handle - ideal for restricted and confined space operation

 **HANDLE**

High-strength, forged lightweight design blades

Replaceable blade inserts for long lasting performance

 **PLUS**



TIPS AND TRICKS TWIST GRIP



Start position horizontal grip, screw open

For vertical cutting turn control handle

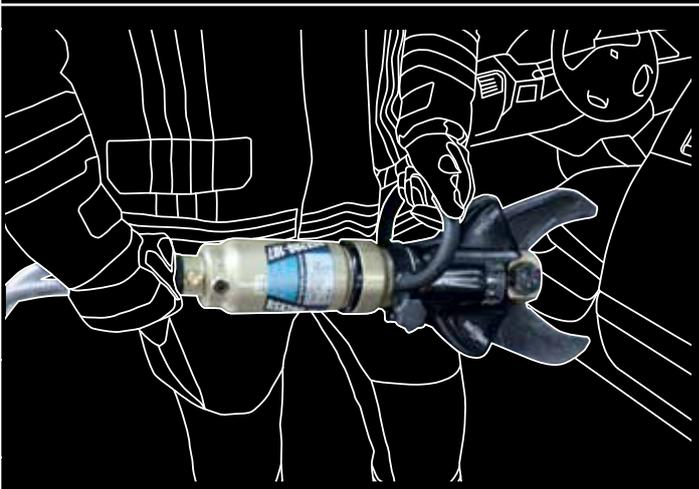
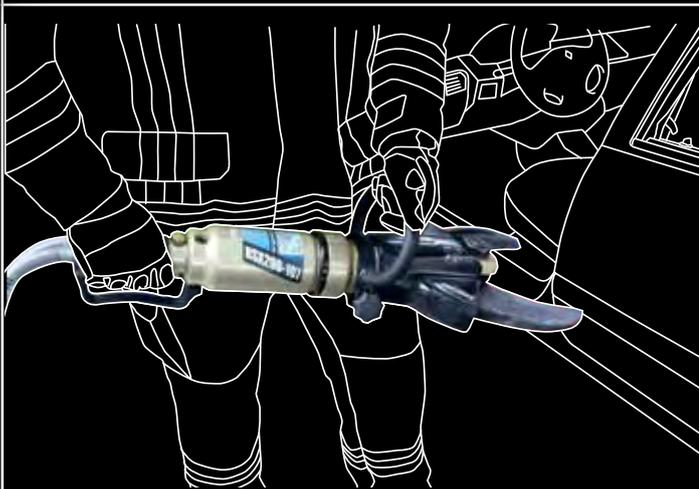

Carrying handle, hinders working

Handle turned away, uninterrupted working possible

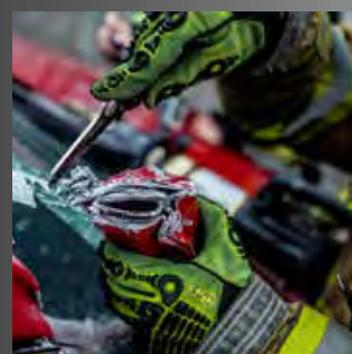
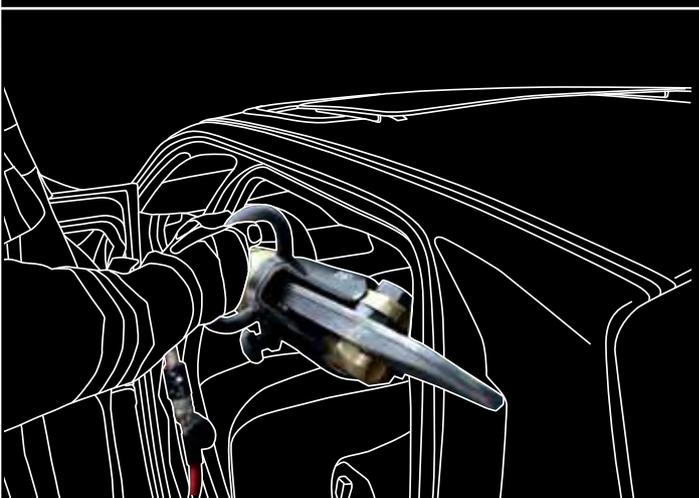
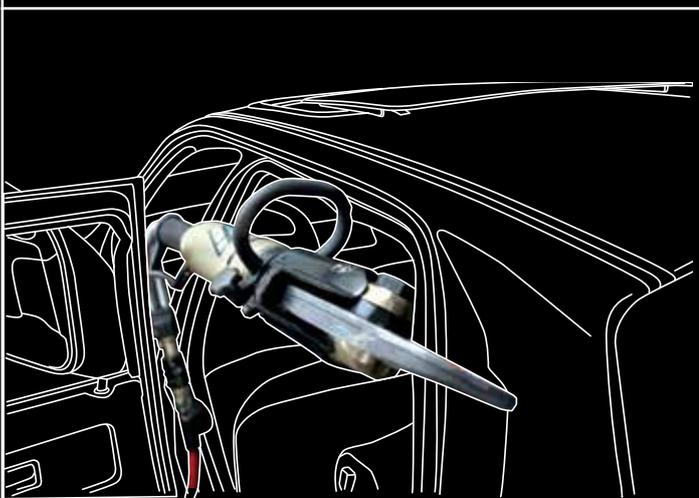

CUTTERS

THE PROVEN BLADE SHAPE - RSX

| Type | RSX 105-29 | RSX 160-50 | RSX 180-80 |
|---------------------------------------|----------------|----------------|----------------|
| Opening | 105 mm | 163 mm | 180 mm |
| Max. cutting force* | 29 t/282 kN | 50 t/493 kN | 80 t/781 kN |
| Max. cutting force (round steel bar)* | ∅ 22 mm | ∅ 32 mm | ∅ 35 mm |
| Weight | 9.3 kg | 14.6 kg | 17.6 kg |
| EN class | AC 105-E-9 | BC 160-H-15 | BC 180-H-18 |
| NFPA class | A5/B4/C5/D6/E6 | A7/B7/C6/D7/E8 | A7/B9/C7/D9/E9 |
| Part no. | 5936780 | 1050539 | 1059226 |

| Type | RSX 185-105 | RSX 200-107 |
|---------------------------------------|----------------|----------------|
| Opening | 185 mm | 200 mm |
| Max. cutting force* | 105 t/1.030 kN | 107 t/1.050 kN |
| Max. cutting force (round steel bar)* | ∅ 45 mm | ∅ 43 mm |
| Weight | 22.5 kg | 19.9 kg |
| EN class | CC 240-H-23 | CC 200-H-20 |
| NFPA class | A9/B9/C9/D9/E9 | A8/B9/C7/D9/E9 |
| Part no. | 5932939 | 5935849 |

...WITH REPLACEABLE INSERTS

| Type | RSX 180-80 PLUS |
|---------------------------------------|-----------------|
| Opening | 180 mm |
| Max. cutting force* | 80 t/781 kN |
| Max. cutting force (round steel bar)* | ∅ 35 mm |
| Weight | 17.8 kg |
| EN class | BC 180-H-18 |
| NFPA class | A7/B9/C7/D9/E9 |
| Part no. | 1059226SIP |

Upgrade to RSX 180-80 PLUS:

| | Weight | Part no. |
|---------------------------|--------|----------|
| RS 170 | 8.3 kg | 1062138 |
| RS(X) 165-65, S 270-71 | 8.3 kg | 1062134 |

TEAM
gold
licence to cut

NEW GENERATION OF CUTTERS

RSU



1 kg lighter due to
new blade shape

 **ULTIMATIVE**



| | |
|--|------------------|
| Type | RSU 200-107 PLUS |
| Opening | 200 mm |
| Max. cutting force* | 107 t/1.050 kN |
| Max. cutting force (round steel bar)* | ∅ 43 mm |
| Weight | 19.9 kg |
| EN class | CC 200-H-20 |
| NFPA class | A8/B9/C7/D9/E9 |
| Part no. | 1069498 |

*according to EN 13204 to 700 ba

ACCESSORIES

| Replacement blade | Part no. | Weight |
|-------------------|----------|--------|
| RSX 105-29 | 1825518 | 1.1 kg |
| RSX 160-50 | 1050557 | 2.3 kg |
| RSX 180-80 | 1059813 | 3.2 kg |
| RSX 185-105 | 1823035 | 4.0 kg |
| RSX 200-107 | 1822608 | 3.4 kg |

| Replacement blade | Weight | Part no. |
|-------------------------------------|--------|----------|
| Blade without insert | | |
| RSX 180-80 PLUS | 3.1 kg | 1059363 |
| RSU 200-107 PLUS | 3.3 kg | 1072763 |
| Blade insert | | |
| RSX 180-80 PLUS | 0.2 kg | 1061568 |
| RSU 200-107 PLUS | 0.3 kg | 1075983 |
| Blade complete (with insert) | | |
| RSX 180-80 PLUS | 3.3 kg | 1059362 |
| RSU 200-107 PLUS | 3.6 kg | 1078502 |
| Inserts in bag (2 pcs.) | | |
| RSX 180-80 PLUS | 1.1 kg | 1061567 |
| RSU 200-107 PLUS | 1.1 kg | 1078501 |

SPECIALISED CUTTERS

C 100-31

- Specialised tool for continuous cutting
- Surplus materials is automatically removed
- Special serrated surface for aggressive cutting

| | |
|---------------------|----------------|
| Opening | 120 mm |
| Max. cutting force* | 31 t/308 kN |
| Weight | 19.5 kg |
| EN class | AC 120-C-20 |
| NFPA class | A4/B3/C5/D6/E6 |
| Part no. | 5935199 |

Replacement blade:

| | |
|-----------------------------------|---------|
| C 100-31 Blade | 1051463 |
| C 100-31 Lower blade right | 1051474 |
| C 100-31 Lower blade left | 1051475 |



S 220-54 AND S 270-71

- Very large opening width
- Serrated blades
- Low weight

| | S 220-54 | S 270-71 |
|---------------------------------------|-----------------|-----------------|
| Opening | 220 mm | 280 mm |
| Max. cutting force* | 54 t/533 kN | 71 t/699 kN |
| Max. cutting force (round steel bar)* | ∅ 25 mm | ∅ 36 mm |
| Weight | 14.4 kg | 17.0 kg |
| EN class | BC 170-H-14 | CC 218-H-17 |
| NFPA class | A6/B7/C6/D8/E8 | A7/B8/C7/D8/E9 |
| Part no. | 1063372 | 5932084 |

Replacement blade:

| | |
|-----------------------|---------|
| S 220-54 Blade | 1063374 |
| S 270-71 Blade | 1808559 |



S 50-14

- Tension-free cutting, no uncontrolled movement of the material being cut
- Compact – for use in confined spaces such as vehicle foot wells
- Lightweight – for one-handed operation

| | |
|---------------------------------------|----------------|
| Opening | 50 mm |
| Max. cutting force* | 14 t/138 kN |
| Max. cutting force (round steel bar)* | ∅ 20 mm |
| Weight | 4.3 kg |
| EN class | AC 50-B-4 |
| NFPA class | A4/B3/C2/D4/E3 |
| Part no. | 2833395 |

Replacement blade:

| | |
|----------------------------|---------|
| S 50-14 Upper blade | 3863670 |
| S 50-14 Lower blade | 3863689 |



*according to EN 13204 to 700 bar

CONCRETE CRUSHER BC 250

- For heavy operation in event of natural disasters, collapsed buildings and industrial incidents
- To break away thick pieces of concrete
- Rotatable grip handle and protection shield
- Changeable tips
- Also available in battery version (E-FORCE)

| | |
|----------------------------|-------------|
| Opening | 250 mm |
| Max. closing force* | 11 t/109 kN |
| Weight | 18.1 kg |
| Part no. | 1063190 |

| | |
|--------------------------------|---------|
| BC 250 Replacement tips | 1065132 |
|--------------------------------|---------|



NEW!

CUTTER S 25-20

- Rescue tool for disasters, such as earthquakes and building collapses
- For cutting of metal rods, chains, locks and reinforcements
- One-handed operation possible

| | |
|----------------------------|---------------|
| Max. cutting force* | 19,5 t/191 kN |
| Weight | 7.7 kg |
| Part no. | 1065612 |

| | |
|---------------------------------|---------|
| S 25-20 Replacement tips | 1065665 |
|---------------------------------|---------|



EFFICIENCY MEETS VARIETY

Cutting, spreading, pushing and pulling - with one tool!



PUSH-CONTROL

Unique WEBER-control for fine-tuned precision handling



360° HANDLE

Removable 360° adjustable handle - ideal for restricted and confined space operation

SPS 370 and SPS 400 with detachable tips and highest cutting class "H"

Blades can be re-sharpened and are complete with a notch for cutting round bars

Compatible with chain set and mechanical rescue rams



TIPS AND TRICKS MAKING A GAP

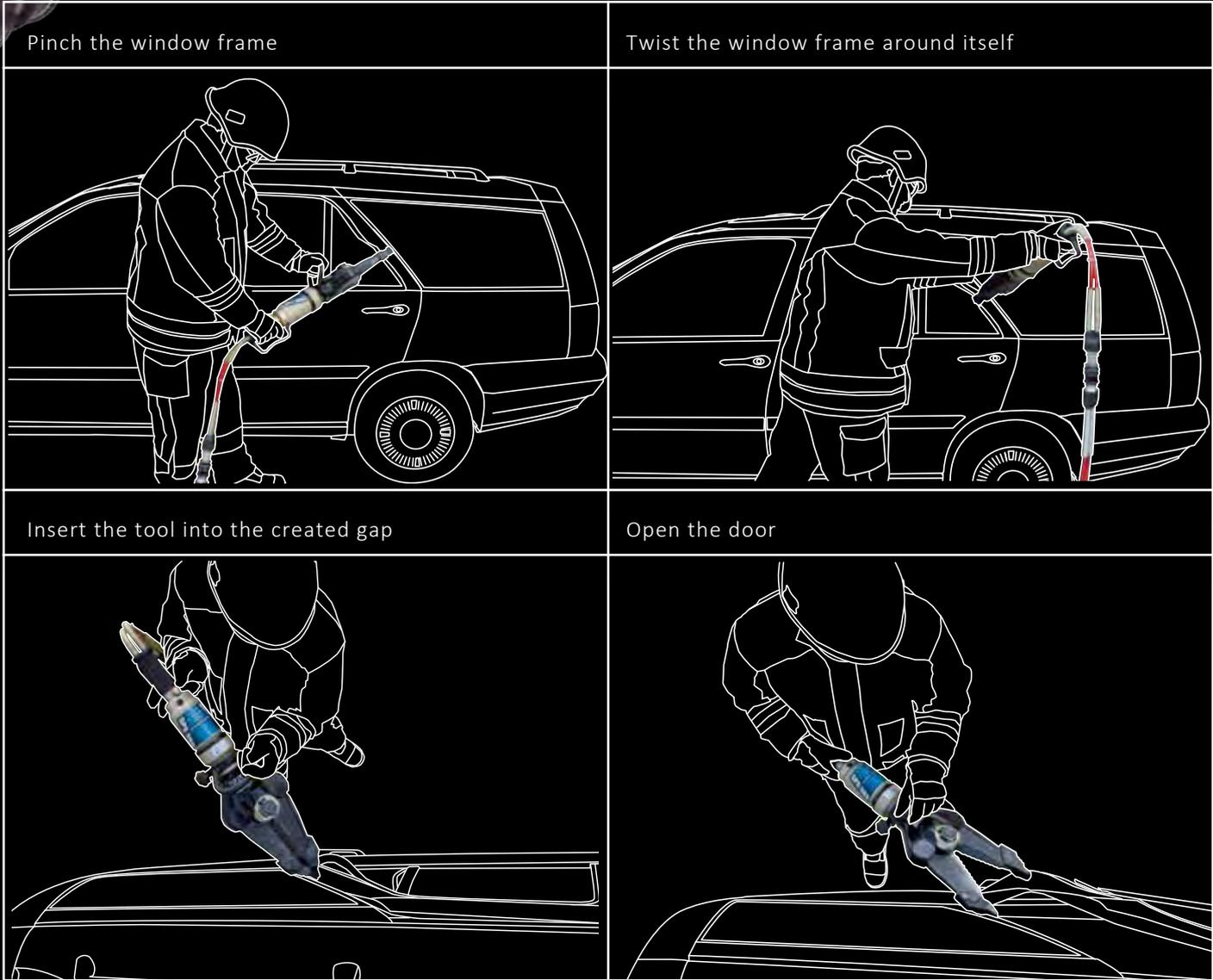

COMBI TOOLS



| | SPS 270 | SPS 360 L | SPS 370 | SPS 400 |
|--|----------------|----------------|----------------|----------------|
| Spreading distance | 270 mm | 360 mm | 370 mm | 425 mm |
| Max. cutting force* | 33 t/324 kN | 50 t/491 kN | 50 t/491 kN | 54 t/526 kN |
| Cutting force (round steel bar) | ∅ 25 mm | ∅ 30 mm | ∅ 30 mm | ∅ 35 mm |
| Spreading force in working range* | 35-591 kN | 45- 783 kN | 44-783 kN | 48 – 726 kN |
| Pulling force (with pulling device) | 39 kN | 52 kN | 52 kN | 63 kN |
| Pulling width (with pulling device) | 385 mm | 444 mm | 390 mm | 404 mm |
| Weight | 10.8 kg | 14.9 kg | 16.0 kg | 18.3 kg |
| EN class | BK 30/265-F-11 | CK 37/360-H-15 | CK 37/370-H-16 | CK 36/420-H-18 |
| NFPA class | A6/B5/C6/D6/E7 | A6/B8/C6/D8/E7 | A6/B8/C6/D8/E7 | A7/B9/C7/D9/E9 |
| Part no. | 1055954 | 1062580 | 1063314 | 5931134 |

*according to EN 13204 to 700 bar



**SPS 370 and SPS 400
with detachable tips!**

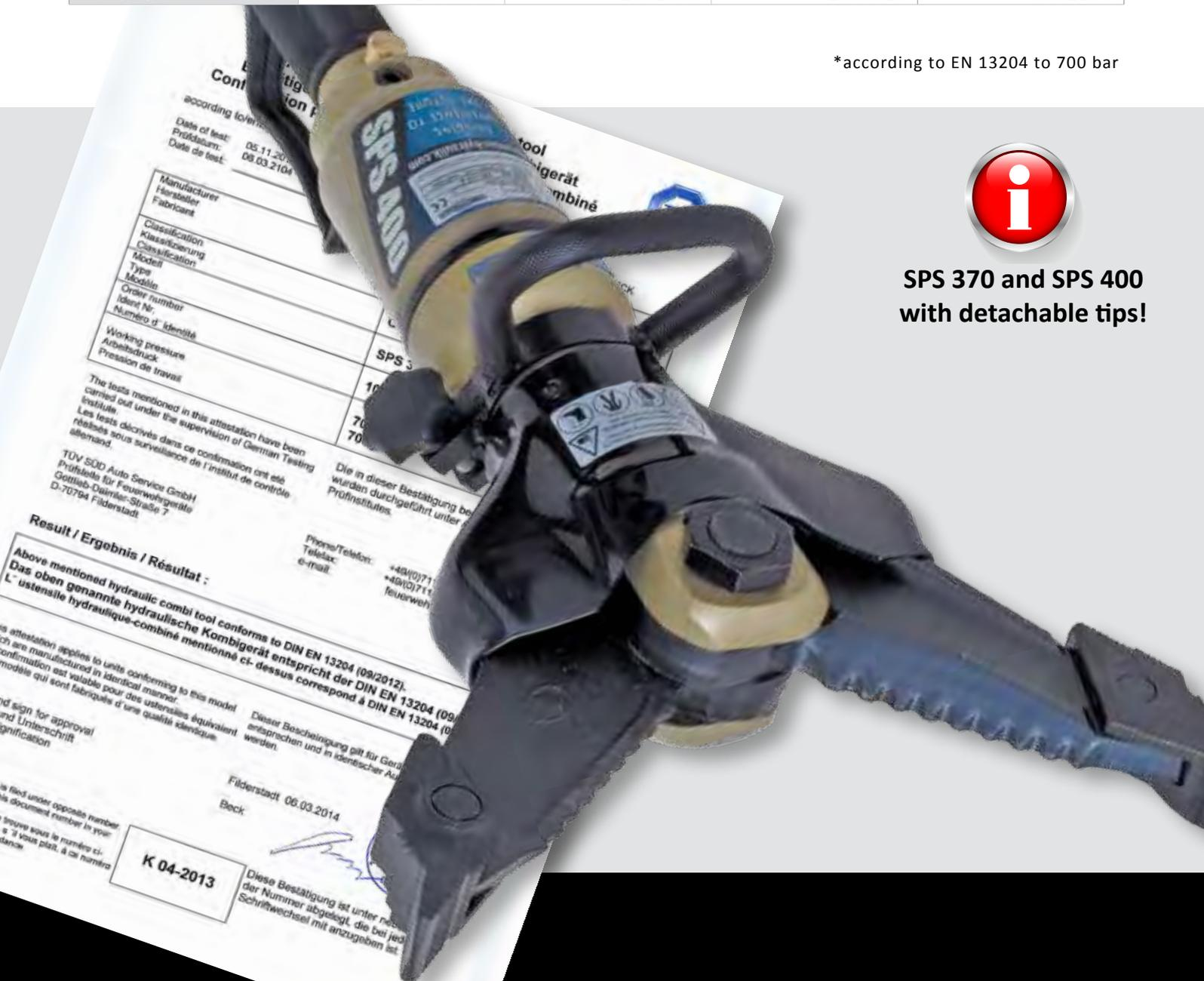

HAND-VARIO SPS 260 H

Manual powered combitool with integrated hydraulic drive

- Small space required for storage
- Agile handling
- Light weight
- Head can be rotated to any position within 360°

| | |
|----------------------------------|----------------|
| Opening | 260 mm |
| Max. cutting force | 29 t/281 kN |
| Cutting force (round steel bar) | Ø 25 mm |
| Spreading force in working range | 33 – 383 kN |
| Weight | 11.2 kg |
| DIN class (DIN 14751-4) | K 25 E-M |
| NFPA class | A6/B6/C6/D7/E7 |
| Part no. | 5934397 |

ACCESSORIES

| | |
|--|---------|
| Replacement (arm) | |
| SPS 270 and SPS 260 H | 1819240 |
| SPS 360 L | 1068993 |
| SPS 370 | 1063315 |
| SPS 400 | 1810499 |
| Pulling device, with pin for fastening the chains on the blades (arms). 2 pieces required | |
| SPS 270 and SPS 260 H | 2096617 |
| SPS 360 L | 2835746 |
| SPS 370 and SPS 400 | 2836033 |
| Chain set | |
| SPS 270 | 571407 |
| SPS 360 L, SPS 370 and SPS 400 | 2819139 |
| Spreader tip | |
| SPS 370 and SPS 400 | 3867323 |
| Rescue ram RZM 740 | |
| SPS 260 H, SPS 270 and SPS 360 L | 1056478 |



Passion meets dynamics

Pushing up to extended length of 1,600 mm



Unique WEBER-control
for fine-tuned precision
handling

Cylinder can be turned under load
due to rotating pushing head

Piston rods with
hard chrome-plated finish

Optimal length graduation -
high power, less weight



TIPS AND TRICKS THIRD DOOR

Make cuts at marked points



Apply rescue ram



Extend rescue ram

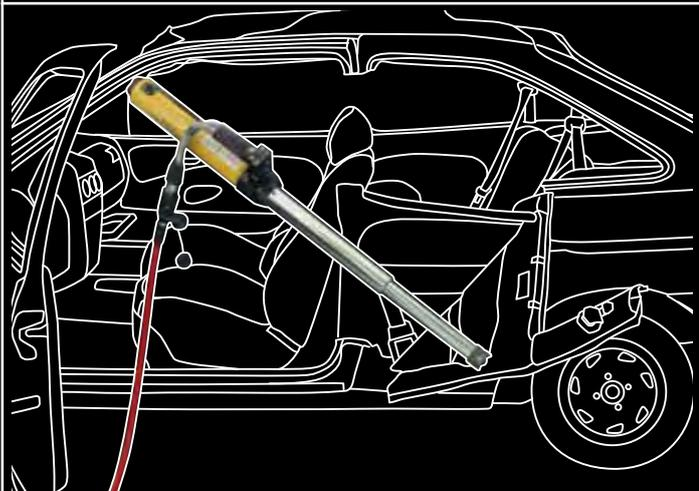

Large rescue opening created



RESCUE RAMS

RESCUE RAMS SINGLE-STAGE

| | RZ 1 – 850 | RZ 2 – 1290 | RZ 3 – 1640 |
|-----------------|--------------|--------------|--------------|
| Pushing force* | 137 kN | 137 kN | 137 kN |
| Pulling force* | 26 kN | 26 kN | 26 kN |
| Closed length | 530 mm | 750 mm | 1,100 mm |
| Piston stroke | 320 mm | 540 mm | 540 mm |
| Extended length | 850 mm | 1,290 mm | 1,640 mm |
| Weight | 11.7 kg | 16.4 kg | 19.4 kg |
| EN class | R 137/320-12 | R 137/540-16 | R 137/540-19 |
| Part no. | 5933803 | 5933781 | 5933765 |

TELESCOPIC RESCUE RAMS

| | RZT 2 – 600 | RZT 2 – 775 | RZT 2 – 1170 | RZT 2 – 1500 |
|-----------------|---------------------|----------------------|----------------------|----------------------|
| Pushing force* | 189.4/99 kN | 189.4/99 kN | 189.4/99 kN | 189.4/99 kN |
| Closed length | 300 mm | 395 mm | 540 mm | 650 mm |
| Piston stroke | 300 mm | 380 mm | 630 mm | 850 mm |
| Extended length | 600 mm | 775 mm | 1,170 mm | 1,500 mm |
| Weight | 9.3 kg | 11.5 kg | 15.2 kg | 18.0 kg |
| EN class | TR 189/165-99/135-9 | TR 189/210-99/170-12 | TR 189/360-99/270-15 | TR 189/470-99/380-18 |
| Part no. | 5936934 | 5931401 | 1050149 | 1050041 |

TELESCOPIC RESCUE RAMS XL

| | RZT 2 – 1500 XL | RZT 3 – 1310 XL |
|-----------------|-----------------------|---------------------|
| Pushing force* | 269,4/129,5 kN | 269,4/129,5/45,4 kN |
| Closed length | 650 mm | 480 mm |
| Piston stroke | 852 mm | 830 mm |
| Extended length | 1,502 mm | 1,310 mm |
| Weight | 20.9 kg | 17.2 kg |
| EN class | TR 269/445-130/407-21 | – |
| Part no. | 5932025 | 5934133 |

*according to EN 13204 to 700 bar

CROSSRAMMER RZ 1-1810

Perfect ram to enlarge a deformed interior and to work inside a vehicle!

- Lightweight and compact
- Body with small diameter
- Large extended length of 1,810 mm



| | |
|------------------------|------------|
| Pushing force | 36.44 kN |
| Closed length | 990 mm |
| Piston stroke | 820 mm |
| Extended length | 1810 mm |
| EN class* | R36/820-14 |
| Weight | 13.9 kg |
| Part no. | 1077052 |

*clearance certificate according to EN 13204

ACCESSORIES

| | Weight | Part no. |
|--|---------------|-----------------|
| Base support front | 6.0 kg | 1824333 |
| Base support back | 9.8 kg | 1824341 |
| Sill support | 10.0 kg | 8121737 |
| Rim adapter set back wheel (Base plate,3 rim adapters and carrying case) | 19.6 kg | 2852144 |
| Rim adapter set back and front wheel (Base plate,3 rim adapters, rim adapter front and carrying case) | 30.7 kg | 2854082 |
| Chain set for RZ 1-3 and for SP 30/35/35 L | 7.4 kg | 571407 |
| Chain set for RZ 1-3 and for SP 43 XL/49/60 | 13.8 kg | 2819139 |
| Adapter for chain set 571407 (2 pcs. required) | 0.7 kg | 3837300 |
| Adapter for chain set 2819139 (2 pcs. required) | 0.8 kg | 3847900 |
| Accessory set RZ 1,2 and 3 (Different pushing heads with storage box) | 6.5 kg | 2823306 |
| Extension 250 mm for RZT 2-600 and RZT 2-775 | 3.4 kg | 3864588 |
| Extension 175 mm for RZ 1-850 | 2.0 kg | 1058482 |
| Extension 250 mm for RZ 1-850 | 2.6 kg | 3838579 |
| Extension 320 mm for RZ 1-850 | 3.0 kg | 1062442 |



PASSION MEETS DYNAMICS

The new WEBER RESCUE E/V 70 W hydraulic power units



Central control unit
(illuminated)

Dual hose reel, available with hoses in different versions and lengths

Ultra-high pressure hoses 2 x 20 m for either operating your chosen tool on double-speed "turbo" operation or for simultaneous operation of two tools



Large carrying handles

Integrated rewinder

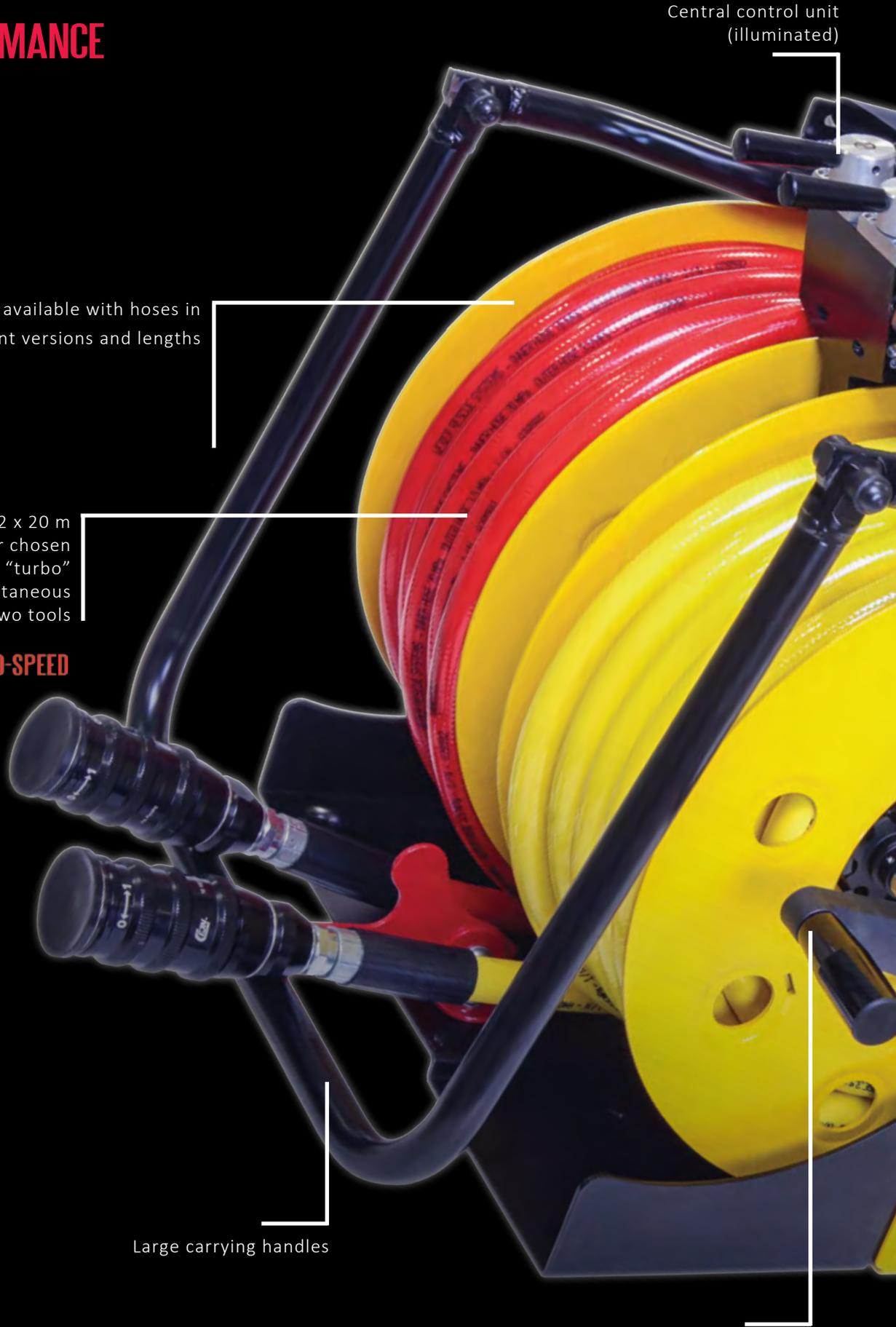

TEAM *gold*

Power
meets speed

Integrated tool brackets,
individually adjustable for all tools

Larger oil volume (6.5 l) for
simultaneous operation of all tools

Higher operating speed due to new
high performance pump

Petrol or electric motor

WEBERRESCUE
SYSTEMS

Compact, modern design



TURBO-SHIFTING

Shift position 1:
Simultaneous operation

Shift position 2:
TURBO mode = double speed

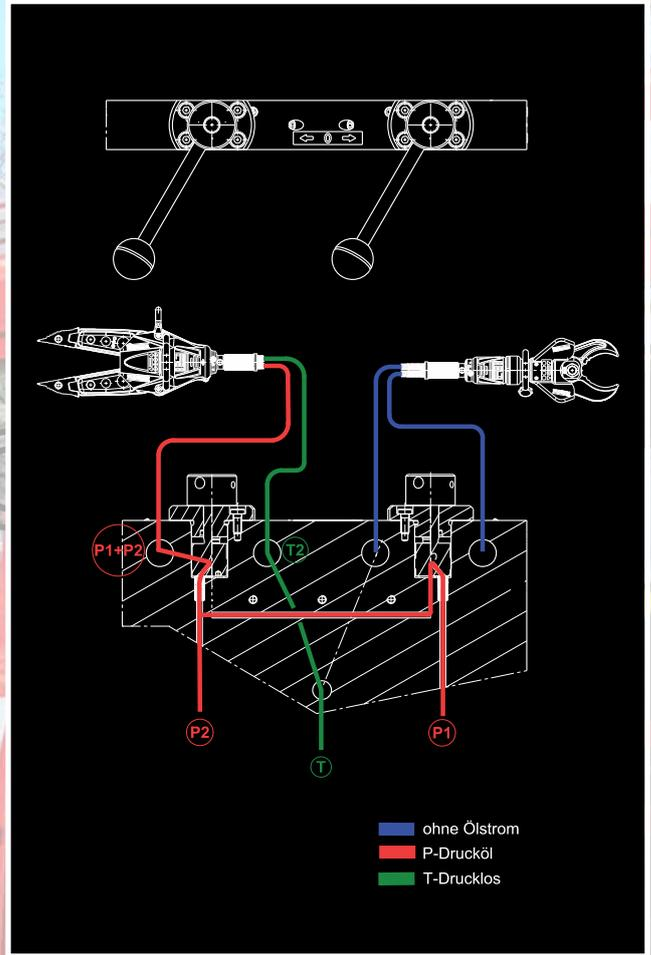
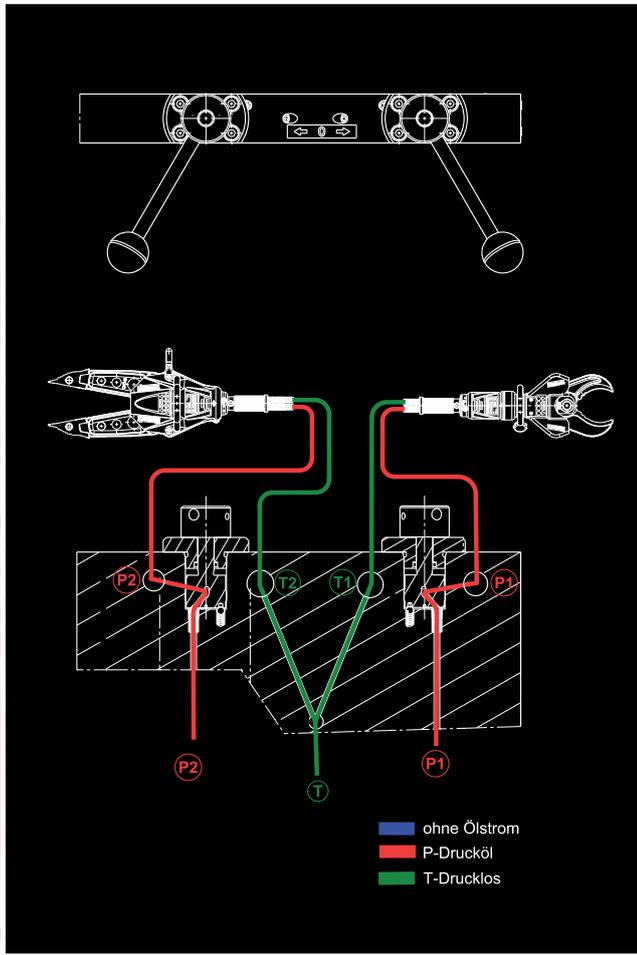

TURBO-SPEED

POWER UNITS

NEW!

E 70 W-SAH 20
V 70 W-SAH 20



| | | |
|--------------------------|---|---|
| Motor | E-Motor 230 V, 50 Hz, 1.3 kW | 4-stroke petrol engine, 3 kW |
| Nominal pressure* | 630/700 bar | 630/700 bar |
| Oil volume | 6.5 l | 6.5 l |
| Weight | 78.5 kg | 82.5 kg |
| EN class | ATO/MTO | ATO/MTO |
| Part no. | 1078718 | 1078719 |



E 70 W-SAH 20
V 70 W-SAH 20
WITH COAX HOSES



| | | |
|--------------------------|---|---|
| Motor | E-Motor 230 V, 50 Hz, 1.3 kW | 4-stroke petrol engine, 3 kW |
| Nominal pressure* | 630/700 bar | 630/700 bar |
| Oil volume | 6.5 l | 6.5 l |
| Weight | 74.0 kg | 78.0 kg |
| EN class | ATO/MTO | ATO/MTO |
| Part no. | 1069283 | 1058332 |



*according to EN 13204 to 700 bar

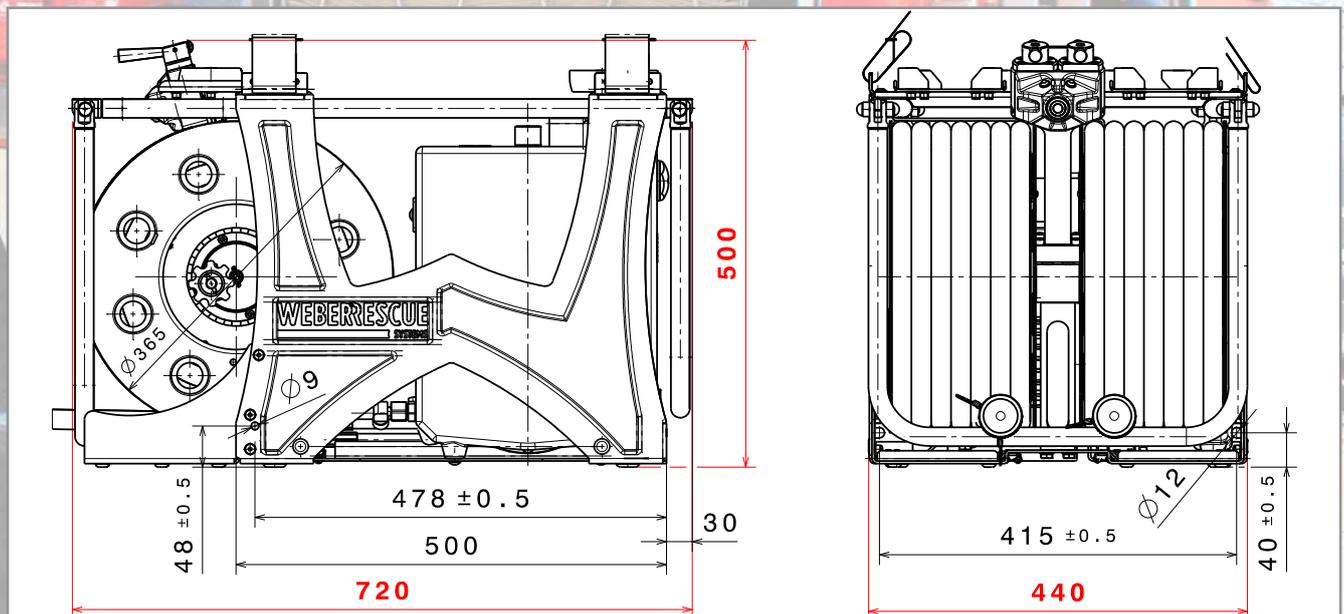

FULL POWER MEETS MINIMUM SPACE

Compact power units with ECO technology

TURBO-SPEED

Operation of 2 tools simultaneously or one tool on "fast" turbo mode (more oil volume for faster working)

Industrial motor



Small, lightweight and flexible, high output – fast working

Will function even when under extreme inclination (up to 30°)

Automatic speed control to reduce noise



TIPS AND TRICKS RESCUE OPENING

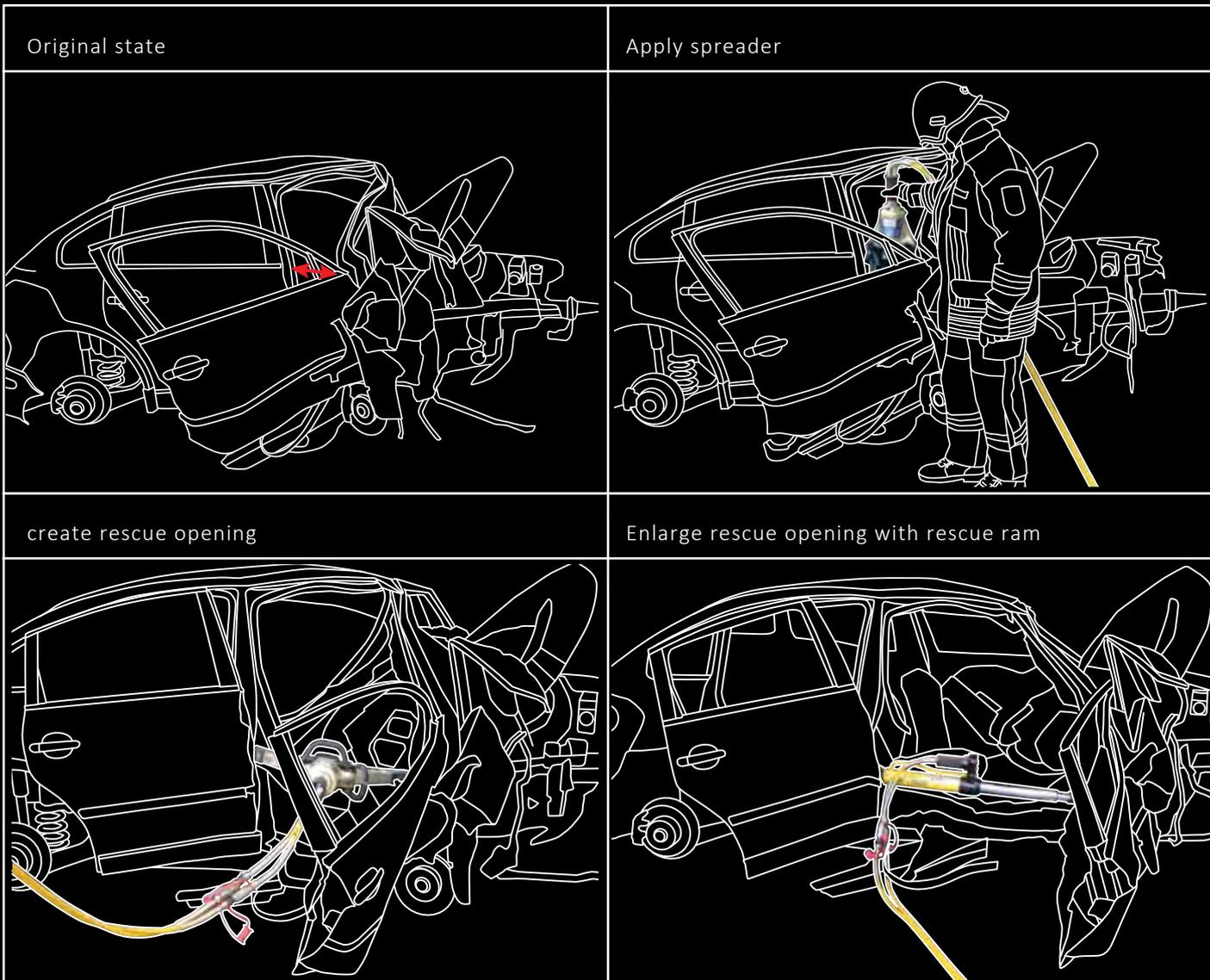

COMPACT POWER UNITS



ECO power

Engine revs are automatically increased when the tool control button is pressed. Returns to idle revs automatically when control button is released.

V 400 ECO ECO

| | V 400 S | V 400 ECO |
|-------------------|----------------------------------|----------------------------------|
| Motor | 4-stroke petrol engine 1.5 kW | 4-stroke petrol engine 1.5 kW |
| Nominal pressure* | 630/700 bar | 630/700 bar |
| Oil volume | 2.5 l | 2.5 l |
| Weight | 17.3 kg | 17.3 kg |
| EN class | STO | STO |
| Part no. | 5934753 | 5936853 |



V 50 ECO

V / E 50 S ECO TURBO-SPEED

| | V 50 ECO | V 50 S | E 50 S |
|-------------------|----------------------------------|----------------------------------|---------------------------------|
| Motor | 4-stroke petrol engine 2.2 kW | 4-stroke petrol engine 2.9 kW | E-Motor 230 V, 50 Hz, 1.3 kW |
| Nominal pressure* | 630/700 bar | 630/700 bar | 630/700 bar |
| Oil volume | 4.0 l | 4.0 l | 4.0 l |
| Weight | 29.9 kg | 31.4 kg | 31.0 kg |
| EN class | ATO/MTO | ATO/MTO | ATO/MTO |
| Part no. | 5935717 | 5934460 | 1070365 |



E-COMPACT

| | |
|-------------------|---------------------------------|
| Motor | E-Motor 230 V, 50 Hz, 1.5 kW |
| Nominal pressure* | 630/700 bar |
| Oil volume | 2.8 l |
| Weight | 11.5 kg |
| EN class | STO |
| Part no. | 1050354 |

- Extremely lightweight and flexible
- One connection with very high output
- Small installation dimension



*according to EN 13204 to 700 bar

MORE COMPACT POWER UNITS...



V-ECOSILENT

| | |
|-------------------|-------------------------------|
| Motor | 4-Stroke Petrol Engine 2.2 kW |
| Nominal pressure* | 630/700 bar |
| Oil volume | 2.7 l |
| Weight | 24.9 kg |
| EN class | ATO/MTO |
| Part no. | 5935318 |



- Extra silent - only 63.9 dB (A)

V-ECOCOMPACT

| | |
|-------------------|-------------------------------|
| Motor | 4-Stroke Petrol Engine 2.2 kW |
| Nominal pressure* | 630/700 bar |
| Oil volume | 3.8 l |
| Weight | 23.9 kg |
| EN class | ATO/MTO |
| Part no. | 1060793 |



- Small, strong, lightweight

*according to EN 13204 to 700 bar



You can find our battery tools on page 40

HOSES



EXTENSION HOSES AND COUPLINGS

- High pressure dual extension hoses
- Filled with oil, fitted with SINGLE couplings

| Length | Part no. yellow | Part no. red | Weight |
|--------|-----------------|--------------|---------|
| 5 m | 2847647 | 2847639 | 4.3 kg |
| 10 m | 2847663 | 2847655 | 7.6 kg |
| 15 m | 2847680 | 2847671 | 9.5 kg |
| 20 m | 2847701 | 2847698 | 13.0 kg |



COAX HOSES

- COAX design hose (Hose-in-hose-system)
- Filled with oil, fitted with SINGLE couplings
- No twisting possible



| Length | Part no. yellow | Part no. red | Weight |
|--------|-----------------|--------------|---------|
| 5 m | 1052602 | 1052605 | 3.3 kg |
| 10 m | 1052603 | 1052606 | 5.5 kg |
| 15 m | 1052604 | 1052607 | 7.7 kg |
| 20 m | 1053457 | 1053455 | 10.0 kg |



Comparison common coupling/ SINGLE coupling



Common coupling:

- 2 actions for coupling
- Coupling only without pressure possible
- Pressure relief plug needed

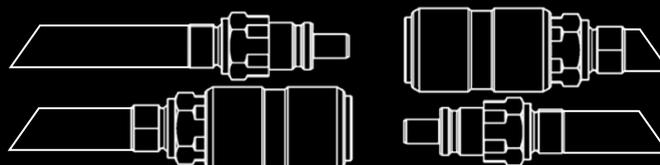

Common coupling can be replaced with SINGLE coupling



SINGLE coupling:

- 1 action for coupling
- Coupling with pending pressure
- No need for any kind of pressure relief plug

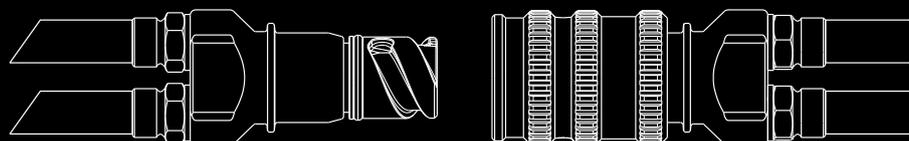

HOSE REELS

FREE STANDING DUAL HOSE REEL HF 20 T

- With carrying frame, complete with 2 x 20 m high-pressure hoses
- Both reels can be operated separately, even when the hoses are under pressure
- With two folding handles for rewinding

| | Twin hose | COAX-hose |
|-----------------|-----------|-----------|
| Weight | 40.0 kg | 34.0 kg |
| Part no. | 5935016 | 1054768 |



FREE STANDING SINGLE HOSE REEL EHF 20 T

- With carrying frame, complete with 20 m high-pressure hose
- Can be operated even when the hose is under pressure
- Folding handle for rewinding

| | Twin hose | COAX-Hose |
|---|-----------|-----------|
| Weight | 22.0 kg | 18.2 kg |
| Part no. high pressure hose red | 5931932 | 1054236 |
| Part no. high pressure hose yellow | 5932491 | 1054754 |
| Part no. high pressure hose blue | 5932661 | 1055333 |
| Part no. high pressure hose black | 5932980 | -- |



HOSE PROTECTION

- Additional protection tools pig tail hoses
- KEVLAR material protective coating and duraskin® cover
- For tool control valves with plastic sleeve
- Velcro fastener

| | |
|-----------------|---------|
| Color | black |
| Length | 30 cm |
| Part no. | 8064563 |

PROTECTION COVER

- For 5-20 m Hoses
- For protection against abrasion and contamination
- KEVLAR material protective coating and duraskin® cover
- Velcro fastener

| Color | red | yellow | blue |
|-----------------|---------|---------|---------|
| Length | 4 m | 4 m | 4 m |
| Part no. | 8051496 | 8051500 | 8058024 |

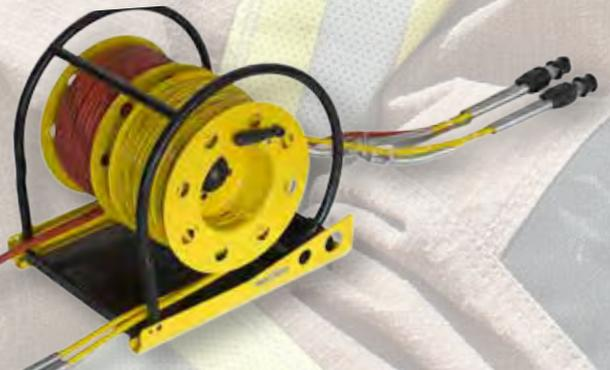

THE NEW MOBILITY

E FORCE 2



Long operating time due to 5.0 Ah capacity (28 V Li-Ion-Battery)

Rocker switch for fine tuned handling even with one hand

LED lights for better view in the working area

Fibre-reinforced case for hardest use

Drive unit retrofittable for E-Force tools Generation 1 and mobile rescue tools

New, efficiency improved drive unit for longer working time and higher operating speed

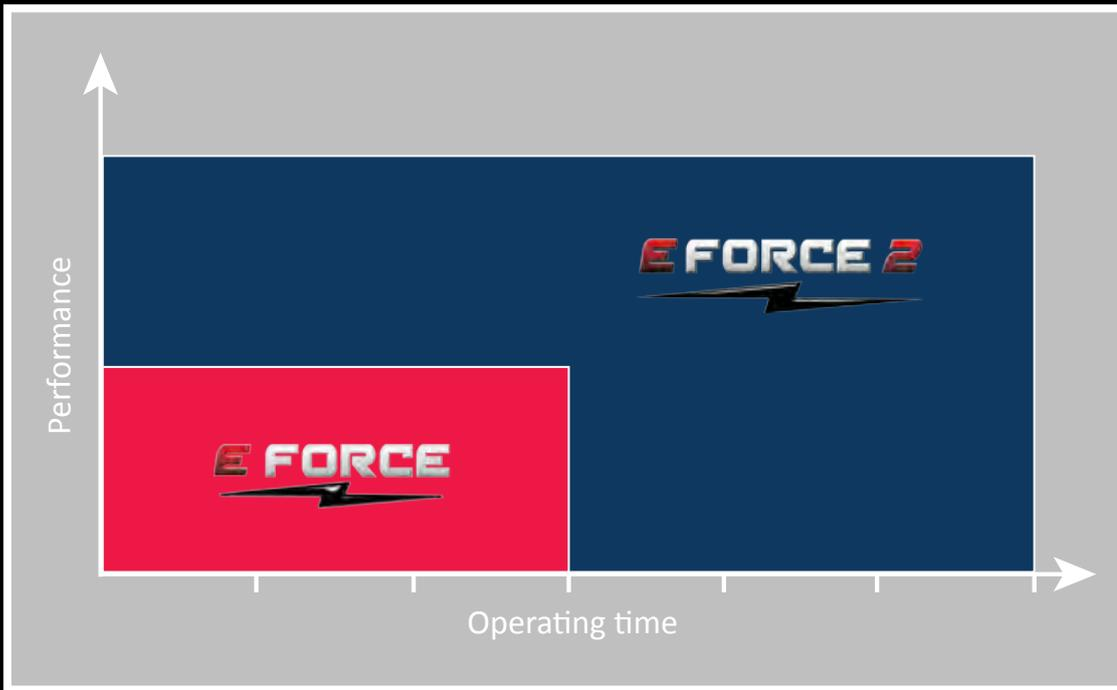

NEW BATTERY TOOL SERIES E-FORCE 2

BLACK SERIES

- New housing with efficiency improved drive unit
- Nearly double working time
- Additionally higher operating speed



Sensitive control with clear identification of open and close movement



BATTERY TOOLS

E-FORCE 2

NEW!

CUTTERS E-FORCE 2

| | RSX 160-50 E-FORCE 2 | RSX 180-80 PLUS E-FORCE 2 | RSU 200-107 PLUS E-FORCE 2 |
|---|-------------------------|------------------------------|-------------------------------|
| Opening | 160 mm | 180 mm | 200 mm |
| Max. cutting force | 50 t/493 kN | 80 t/781 kN | 107 t/1.050 kN |
| Max. cutting force (round steel bar) | ∅ 32 mm | ∅ 35 mm | ∅ 43 mm |
| Weight (incl. battery) | 18.2 kg | 21.4 kg | 23.5 kg |
| NFPA class | A6/B7/C6/D7/E8 | A7/B9/C7/D9/E9 | A8/B9/C7/D9/E9 |
| Part no. | 1077690 | 1075255 | 1075262 |

COMBI TOOLS E-FORCE 2

| | SPS 270 E-FORCE 2 | SPS 360 L E-FORCE 2 | SPS 370 E-FORCE 2 |
|---|-------------------|---------------------|-------------------|
| Spreading force | 35 - 591 kN | 45 - 783 kN | 44 - 783 kN |
| Max. cutting force | 33 t/ 324 kN | 50 t/ 491 kN | 50 t/ 491 kN |
| Max. cutting force (round steel bar) | ∅ 25 mm | ∅ 30 mm | ∅ 30 mm |
| Spreading distance | 270 mm | 360 mm | 370 mm |
| Pulling width | 385 mm | 444 mm | 390 mm |
| Weight (incl. battery) | 14.2 kg | 18.6 kg | 19.4 kg |
| NFPA class | A6/B5/C6/D6/E7 | A6/B8/C6/D8/E7 | A6/B8/C6/D8/E7 |
| Part no. | 1075250 | 1074458 | 1077676 |



Batteries not
included in delivery!

BATTERY TOOLS



RSU 200-107 PLUS E-FORCE 2



SPS 370 E-FORCE 2



RSX 180-80 PLUS E-FORCE 2



SPS 360 L E-FORCE 2



RSX 160-50 PLUS E-FORCE 2



SPS 270 E-FORCE 2



BATTERY TOOLS

E-FORCE 2
NEW!

Spreaders E-FORCE 2

| | SP 35 AS E-FORCE 2 | SP 53 BS E-FORCE 2 |
|------------------------|--------------------|--------------------|
| Spreading force | 38 - 171 kN | 56 - 421 kN |
| Closing force | 76 kN | 100 kN |
| Spreading distance | 600 mm | 800 mm |
| Weight (incl. battery) | 18.3 kg | 24.0 kg |
| EN class | AS 35/600-19 | BS 53/800-24 |
| Part no. | 1075263 | 1077791 |



SP 35 AS E-FORCE 2

SP 53 BS E-FORCE 2

Rescue ram E-FORCE 2

NEW!

| | RZ 1-910 E-FORCE 2 | RZ 2-1360 E-FORCE 2 |
|------------------------|--------------------|---------------------|
| Pushing force | 111.3 kN | 108/62 kN |
| Closed length | 542 mm | 560 mm |
| Piston stroke | 368 mm | 800 mm |
| Extended length | 910 mm | 1,360 mm |
| Weight (incl. battery) | 15.7 kg | 18.9 kg |
| Part no. | 1075272 | 1078342 |



RZ 1-910 E-FORCE 2



RZ 2-1360 E-FORCE 2

BLACK SERIES

SPECIALISED BATTERY TOOLS

E FORCE 2

Power wedge SPK 250 E-FORCE 2

| | |
|------------------------|---------------|
| Insertion height | 8 mm |
| Max. lifting height | 58 mm |
| Lifting force | 25 t / 245 kN |
| Weight (incl. battery) | 12.6 kg |
| Part no. | 1077812 |



Door opener DO 140 E-FORCE 2

| | |
|------------------------|---------------|
| Piston stroke | 140 mm |
| Pushing force* | 11 t / 105 kN |
| Weight (incl. battery) | 14.3 kg |
| Part no. | 1078140 |

NEW!

Concrete crusher BC 250 E-FORCE 2

| | |
|------------------------|-------------|
| Opening | 250 mm |
| Closing force | 11 t/109 kN |
| Weight (incl. battery) | 21.5 kg |
| Part no. | 1077721 |

BLACK SERIES

Accessories

| Accessories | Weight | Part no. |
|---|---------|----------|
| Mechanical rescue ram RZM 740 for SPS 270 E-FORCE 2 and SPS 360 L E-FORCE 2 | 6.9 kg | 1056478 |
| Chain set for SPS 270 E-FORCE 2 | 7.4 kg | 571407 |
| for SPS 360 L / SPS 370 E-FORCE 2 | 13.8 kg | 2819139 |
| for SP 35 AS / SP 53 BS E-FORCE 2 | 13.8 kg | 571415 |
| Pulling device (2 pcs. required) | | |
| for SPS 270 E-FORCE 2 | 1.4 kg | 2096617 |
| for SPS 360 L E-FORCE 2 | 1.4 kg | 2835746 |
| for SPS 370 E-FORCE 2 | 1.4 kg | 2836033 |
| Extension for RZ 1-910 E-FORCE 2 | | |
| 175 mm | 2.0 kg | 1058482 |
| 250 mm | 2.6 kg | 3838579 |



BATTERY POWER UNITS



B-COMPACT

- The advantages of the successful power unit E-COMPACT in combination with battery power!
- Extremely lightweight and flexible
- One connection with very high output
- Small stowage dimension
- Ability to connect 2 batteries
- Permanent operation by using a power supply
- Delivered without battery

| | |
|------------------------------------|-------------|
| Nominal pressure | 630/700 bar |
| Oilvolume | 2.8 l |
| Weight (oil-filled, incl. battery) | 11.9 kg |
| Part no. | 1068081 |



BATTERY PAC

- Extremely lightweight hydraulic power unit with 28 V battery drive
- Back-pack solution with wide and comfortable belts for safe fit
- Nominal pressure and tank volume constructed to drive all WEBER rescue tools (including XL rescue rams)
- Supplied without batteries as standard, 2nd battery optional to double the operation time (10 Ah)

| | |
|------------------------------------|-------------|
| Nominal pressure | 630/700 bar |
| Oilvolume | 2.5 l |
| Weight (oil-filled, incl. battery) | 10.0 kg |
| Part no. | 1067360 |



ACCESSORIES BATTERY TOOLS

| | Weight | Part no. |
|---|--------|----------|
| Spare battery 28 V / 3 Ah | 1.0 kg | 1053785 |
| Spare battery 28 V / 5 Ah | 1.0 kg | 1075189 |
| Battery pouch for one battery (without belt) | 0.2 kg | 1056921 |
| Belt for battery pouch | 0.1 kg | 1056920 |
| On-vehicle charger (without plug) | 1.0 kg | 1060423 |
| Mains charger 110 V for one battery | 0.8 kg | 1054099 |
| Mains charger 230 V for one battery | 0.8 kg | 1054097 |
| Power supply 230 V | 4.0 kg | 1060422 |
| Power supply 110 V | 5.0 kg | 1060426 |
| Transport bag for SPS 270 E-FORCE 2 or SPS 360 L E-FORCE 2 | 1.8 kg | 1058128 |



**Battery compatible with
MILWAUKEE battery-
operated saws!**

BATTERY SAWS AND ACCESSORIES

| | Weight | Part no. |
|---|--------|---|
| MILWAUKEE Reciprocating saw V 28 SET Recip saw tool, 2 batteries 28 V / 3 Ah, mains charger 230 V for one battery, carrying case | 9.0 kg | 1054063 |
| MILWAUKEE Reciprocating saw tool V 28 without battery, mains charger and carrying case | 3.0 kg | 1059177 |
| Blade EXTRICATION SET 4 pcs blades 150 mm 6 pcs blades 230 mm | 0.4 kg | 1078478 |
| Blade SET DIN 5 pcs blades wood / plastic 230 mm 5 pcs blades wood 230 mm 5 pcs blades wood with nails 150 mm 5 pcs blades for metal 230 mm | 0.3 kg | 1059189 1059182 1059183 1059184 1059186 |
| Blade SET VU 5 pcs blades for metal 150 mm 5 pcs blades for metal 230 mm 5 pcs blades universal 200 mm | 0.2 kg | 1059190 1059185 1059186 1059187 |
| MILWAUKEE Metal cutting circular saw V 28 SET, 2 batteries 28 V / 3 Ah, mains charger 230 V for one battery, carrying case | 9.2 kg | 1054064 |
| MILWAUKEE Metal circular cutting saw V 28 without battery, mains charger and carrying case | 3.2 kg | 1059178 |
| Circular saw blades | 0.2 kg | 1059188 |



Milwaukee

LIGHT TOOLS

- Extremely lightweight and versatile
- Rescue tools for disasters, such as earthquakes and building collapses
- All tools weigh less than 10 kg
- All tools are matched to the power unit
- One-handed operation possible with tools
- Special transport system for usage in difficult terrain (e.g. helicopter transport)

NEW!

Cutters S 140-26 light

| | |
|--------------------------------------|----------------|
| Opening | 140 mm |
| Max. cutting force* | 255 kN |
| Max. cutting force (round steel bar) | 25 mm |
| EN class | AC-115-D-8 |
| NFPA class | A5/B3/C3/D6/E7 |
| Weight | 7.9 kg |
| Part no. | 1075652 |



S 140-26 light

Combi tools SPS 270 light

| | |
|---------------------------------------|-------------------|
| Spreading distance | 270 mm |
| Max. cutting force* | bis 48 t / 471 kN |
| Max. cutting force* (round steel bar) | 25 mm |
| Pulling force | 52 kN |
| EN class | E |
| NFPA class | A6/B6/C6/D7/E7 |
| Weight | 8.9 kg |
| Part no. | 1075680 |



SPS 270 light

Rescue ram light

| | RZ 1-465 light | RZ 1-580 light |
|------------------------|----------------|----------------|
| Pushing force* | 111.3 kN | 111.3 kN |
| Closed length | 317 mm | 395 mm |
| Piston stroke | 150 mm | 185 mm |
| Extended length | 467 mm | 580 mm |
| EN class* | R 111/150-7 | R 110/185-9 |
| Weight (incl. battery) | 6.9 kg | 8.7 kg |
| Part no. | 1075651 | 1075944 |



RZ 1-465 light



We also offer an extensive range of pneumatic solutions!



Power unit V 400 light

| | |
|---------------------|-------------------------------------|
| Motor | 4-stroke petrol engine HONDA 1.2 kW |
| Nominal pressure | 700 bar |
| Oil volume | 1.5 l |
| Weight (oil-filled) | 14.2 kg |
| Part no. | 1075621 |

STROKE MEETS CONTROL

Tools for lifting, pushing and moving of loads



Save transport and storage



Hydraulic door opener for rapid forcible entry and lifting of concrete slabs, steel beams etc.



Hand pump for independent operations

TIPS AND TRICKS

DOOR OPENING, FROM ABOVE

Bend window frame open



Apply spreader from above in gap

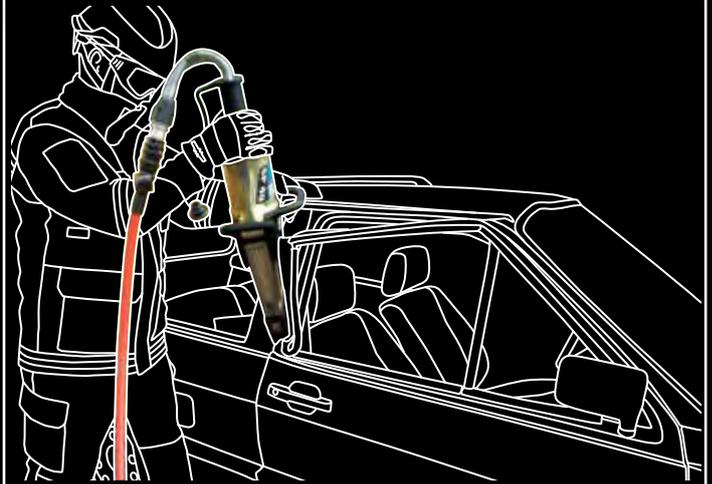

During closing the spreader slides in (gravity)

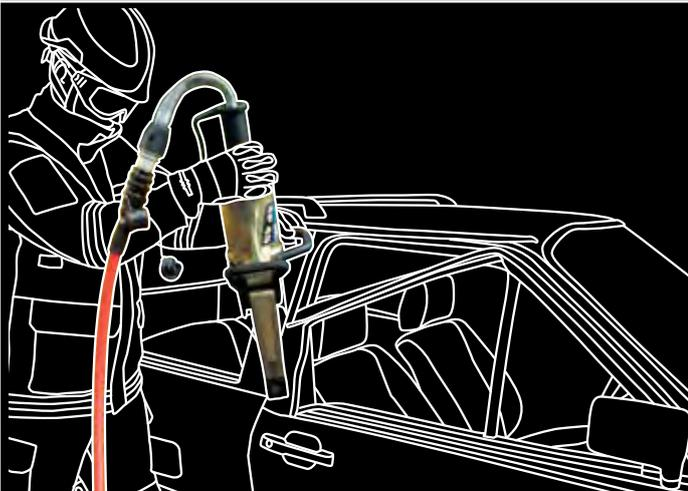

Re-apply the spreader

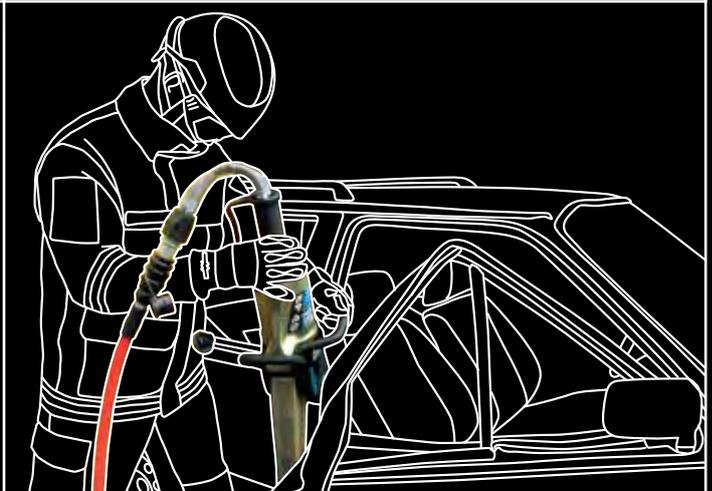

LIFTING EQUIPMENT

LIFTING SETS

- Single-acting hydraulic cylinders
- Lifting power 137 kN
- Including hand pump and accessories
- DIN 14800



| | Lifting set 1 | Lifting set 2 |
|---------------------|---------------|---------------|
| No. of parts | 18 | 13 |
| No. of cases | 2 | 1 |
| Weight | 77.0 kg | 51.0 kg |
| Part no. | 5933552 | 5933544 |

Picture: Lifting set 2

DOOR OPENING KIT

- For rapid forcible entry
- For lifting heavy objects (concrete slabs, steel beams etc.)
- Including hand pump, hose, door opener and transport case

| | |
|-----------------|---------|
| Weight | 16.0 kg |
| Part no. | 1075344 |



DOOR OPENER SINGLE ACTION

| | |
|----------------------|----------|
| Pushing force | 114.5 kN |
| Piston stroke | 120 mm |
| Weight | 7.1 kg |
| Part no. | 1075922 |

*according to EN 13204 to 700 bar

HYDRAULIC LIFTER SBH 15-255

- Precise hydraulic lifting and lowering
- Minimal set-up time
- Control unit MSE required
- EN 13204 and NFPA 1936 certified

| | |
|-------------------------|---------|
| Max. lifting force | 148 kN |
| Max. lifting force claw | 100 kN |
| Insertion height | 39.5 mm |
| Stroke | 255 mm |
| Weight | 20.9 kg |
| Part no. | 2839075 |



Connection lifter/MSE through extension hoses or hose reel with couplings without quickstop

MOBILE CONTROL UNIT MSE 15-255

- simultaneous and independent operation of two lifters (1 pressure connection per lifter required)
- Safety steering according DIN 14751



| | |
|----------|---------|
| Weight | 8.6 kg |
| Part no. | 2839440 |

BÜFFEL B 5 AND B 10

| | B 5 | B 10 |
|---------------|----------|-----------|
| Lifting force | 5,000 kg | 10,000 kg |
| Closed height | 660 mm | 800 mm |
| Piston stroke | 280 mm | 350 mm |
| Weight | 28.2 kg | 38.5 kg |
| Part no. | 1013149 | 198471 |

ACCESSORIES

| | B 5 | B 10 |
|----------------|---------|---------|
| Spherical base | 4133323 | 4129881 |
| Square base | 4133315 | 4129873 |
| Bearing plate | | 32255 |



SPEED MEETS SAFETY

The improved stabilisation system STAB-FAST MK2

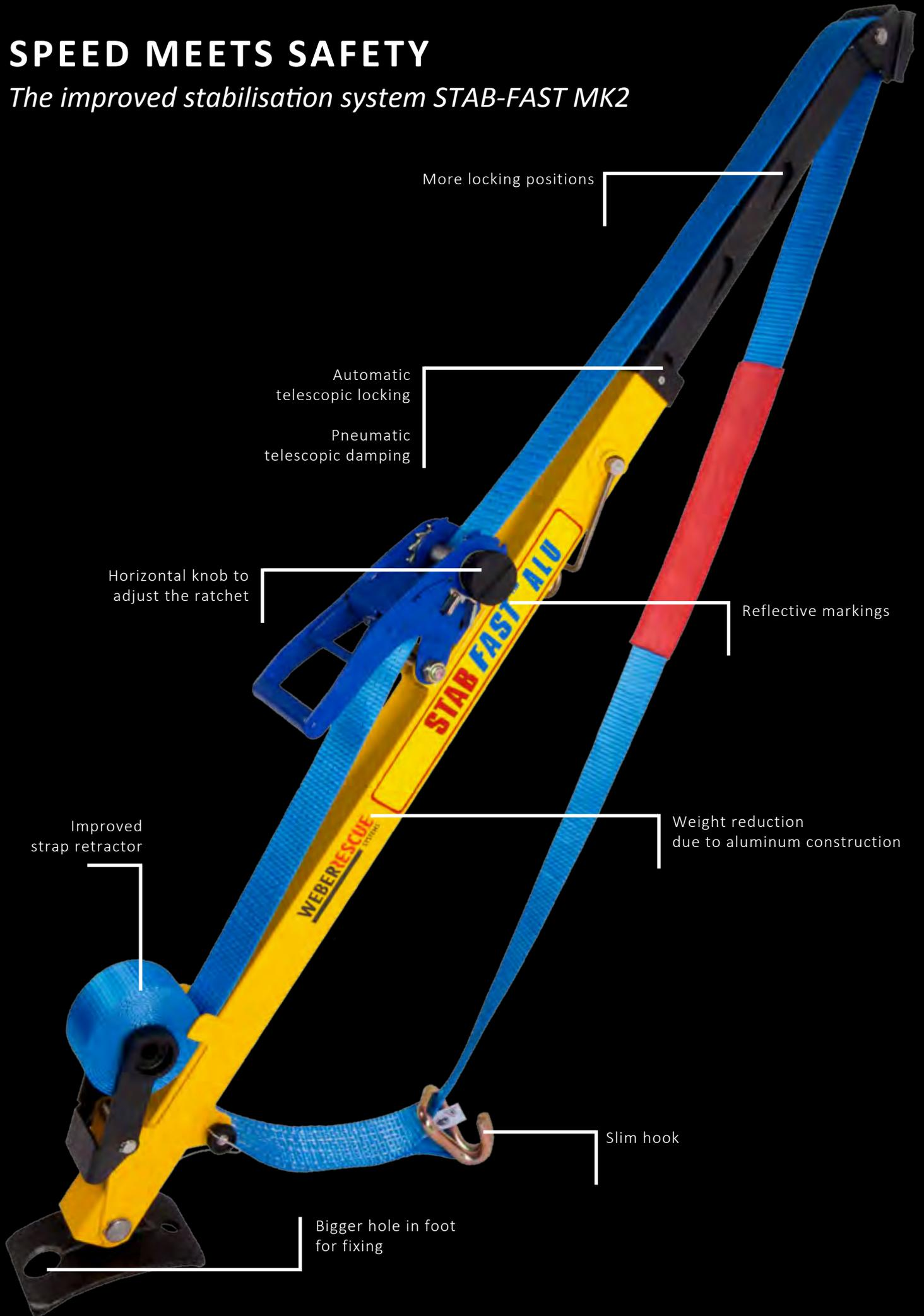

More locking positions

Automatic telescopic locking

Pneumatic telescopic damping

Horizontal knob to adjust the ratchet

Reflective markings

Improved strap retractor

Weight reduction due to aluminum construction

Slim hook

Bigger hole in foot for fixing

TIPS AND TRICKS

PULLING STEERING WHEEL

Strike a hole into the windscreen

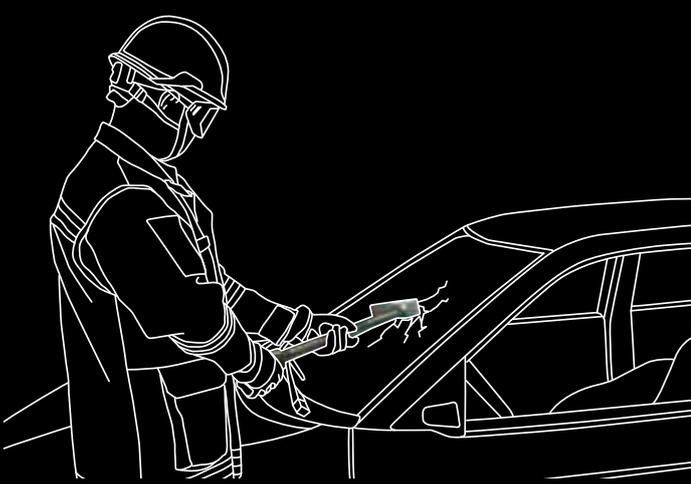

Place a chain around the steering wheel and pull it through the windscreen

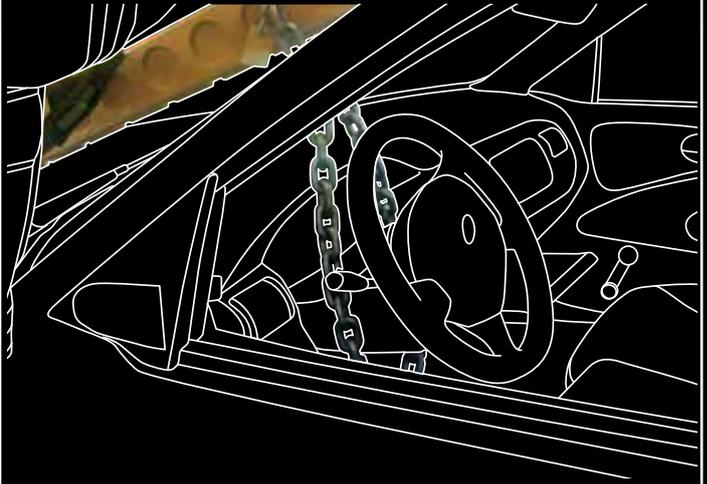

Position suitable timber piece



Apply spreader and pull steering wheel upwards

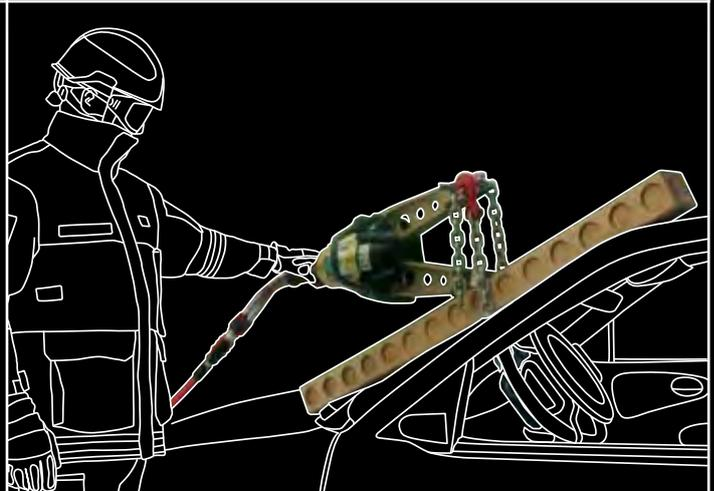



The new STAB-FAST ALU!!
Lighter due to aluminium construction
Improved knife

STABILISATION

STAB-FAST ALU

- TÜV and CE certified
- Easy, versatile and safe system
- Quick and easy installation

NEW!



STAB FAST ALU



STAB FAST ALU Basic



STAB FAST ALU XL

| | STAB-FAST ALU | STAB-FAST ALU Basic | STAB-FAST ALU XL |
|--|--|--|--|
| Content | 3 struts, hook blade, wedge and 2 transport bags | 2 struts, hook blade and transport bag | 2 struts, hook blade and transport bag |
| Closed Length | 1,070 mm | 1,070 mm | 1,500 mm |
| Extended Length | 1,720 mm | 1,720 mm | 2,500 mm |
| Weight per strut | 7.2 kg | 7.2 kg | 10.3 kg |
| Maximum load in longitudinal direction of strut | 1,500 kg | 1,500 kg | 2,500 kg |
| Length of strap | 5,000 mm | 5,000 mm | 10,000 mm |
| Maximum load of strap | 5,000 kg | 5,000 kg | 5,000 kg |
| Maximum load of hook | 2,500 kg | 2,500 kg | 2,500 kg |
| Bag size | 1,100 x 300 x 120 mm | 1,100 x 300 x 120 mm | 1,600 x 500 x 180 mm |
| Weight | 33.0 kg | 19.0 kg | 30.0 kg |
| Part no. | 1078418 | 1078419 | 1078420 |

STABILISATION

STAB-PACK

- To stabilise the vehicle simply and precisely
- Safety due to easy handling
- Adjustable by two integrated wood wedges
- Safety due to large footprint

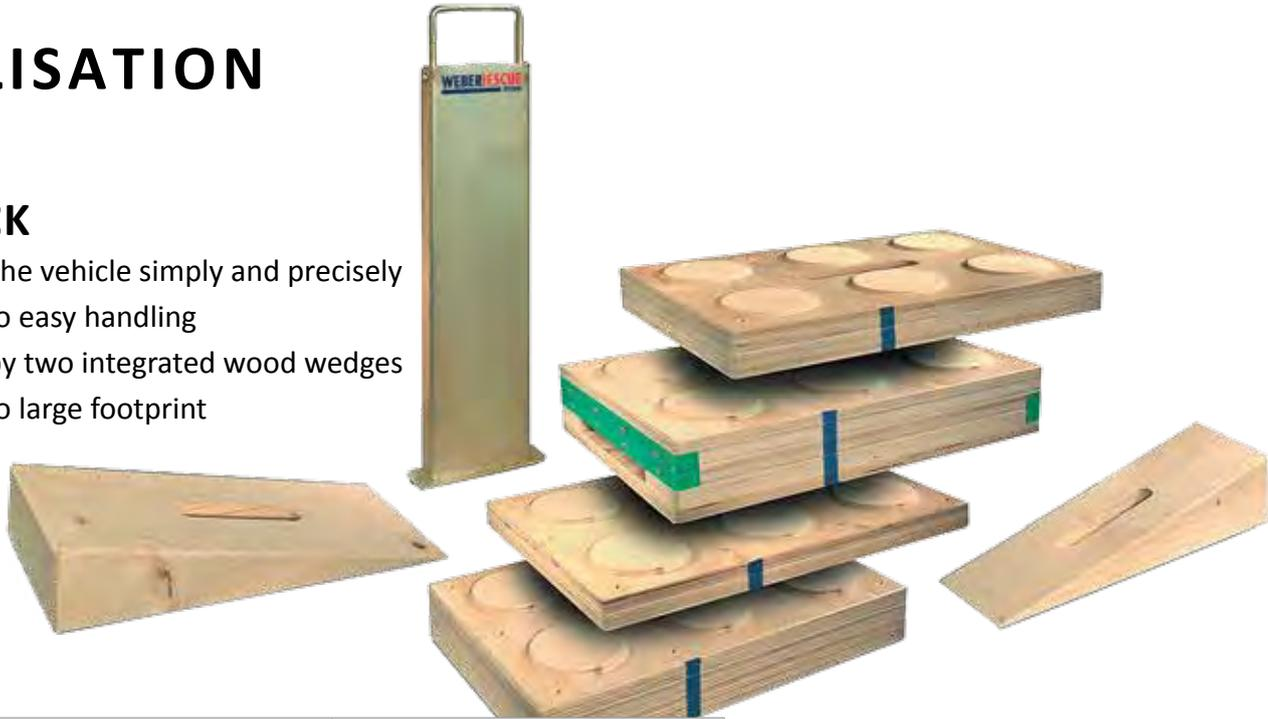

| | STAB-PACK | STAB-PACK-SET |
|------------------|--------------------|---|
| Dimension | 270 x 180 x 335 mm | 600 x 400 x 320 mm (4 pcs. in Eurobox) |
| Weight | 8.6 kg | 38.0 kg |
| Part no. | 8044406 | 1052771 |



MORE STABILISATION...

STAB-LOCK-SET

- Water-proofed bonded beech plywood
- Similar to the Lego system
- Compatible to STAB-PACK system

| Set | Dimensions | Weight | Anzahl |
|-------------------------|--------------------|---------|--------|
| Eurobox | 600 x 400 x 320 mm | 3.3 kg | 1 |
| Baseplate 4 x 6 | 540 x 360 x 36 mm | 4.9 kg | 1 |
| Wedge | 230 x 90 x 60 mm | 1.5 kg | 4 |
| Top 2 x 3 | 270 x 185 x 22 mm | 1.3 kg | 2 |
| Top 2 x 3 s | 270 x 185 x 22 mm | 1.1 kg | 2 |
| 4 square 2 x 3 | 270 x 185 x 95 mm | 3.0 kg | 1 |
| 4 square 2 x 6 | 540 x 185 x 95 mm | 6.4 kg | 1 |
| 4 square 1 x 3 | 270 x 95 x 95 mm | 1.5 kg | 1 |
| 4 square 1 x 3 s | 270 x 95 x 95 mm | 1.4 kg | 1 |
| 4 square 1 x 6 | 540 x 95 x 95 mm | 3.1 kg | 1 |
| 4 square 1 x 6 s | 540 x 95 x 95 mm | 3.0 kg | 1 |
| Set-Nr. 1052770 | | 30.5 kg | |

ADDITIONAL PARTS STAB-LOCK

| Typ | Dimensions | Weight | Part no. |
|------------------------|---------------------|---------|----------|
| 4 square 1 x 9 | 810 x 95 x 95 mm | 4.4 kg | 1052589 |
| 4 square 2 x 9 | 810 x 185 x 95 mm | 8.6 kg | 1051848 |
| 4 square 1 x 12 | 1,080 x 95 x 95 mm | 5.4 kg | 1052591 |
| 4 square 2 x 12 | 1,080 x 185 x 95 mm | 11.4 kg | 1051849 |
| 4 square 1 x 15 | 1,350 x 95 x 95 mm | 7.4 kg | 1052592 |
| 4 square 2 x 15 | 1,350 x 185 x 95 mm | 14.8 kg | 1051850 |
| 4 square 1 x 18 | 1,620 x 95 x 95 mm | 9.0 kg | 1052593 |
| 4 square 2 x 18 | 1,620 x 185 x 95 mm | 17.2 kg | 1051851 |



STAB-LOCK 2x3



STAB-LOCK 1x6s



STAB-LOCK Wedge



STAB-LOCK 1x12



STAB-LOCK 2x18

STAB-FIX

- Recycled PE
- Durable and shatterproof
- Oil- and chemical resistant
- Maximum load capacity up to 110 kg/cm²
- No slipping because of pyramid design

| Typ | Dimensions | Weight | schwarz | gelb |
|-------------------------|--------------------|---------|---------|---------|
| Chock | 640 x 140 x 280 mm | 7.4 kg | 8066140 | 8137226 |
| Slide Step Chock | 620 x 170 x 275 mm | 10.0 kg | 1067933 | 1068551 |
| Block 25 | 230 x 230 x 25 mm | 1.4 kg | 8063818 | 8137170 |
| Block 50 | 230 x 230 x 50 mm | 2.3 kg | 8063826 | 8137188 |
| Block 75 | 230 x 230 x 75 mm | 3.4 kg | 8063834 | 8137196 |
| Wedge 75 | 215 x 75 x 80 mm | 0.7 kg | 3191796 | 8137218 |
| Wedge 150 | 215 x 150 x 80 mm | 1.3 kg | 3191800 | 8137200 |
| 4 square 100 | 100 x 100 x 450 mm | 2.7 kg | 8137242 | 8137234 |
| 4 square 150 | 150 x 150 x 600 mm | 12.0 kg | 8138575 | 8138494 |
| Bag for 100 | | 0.5 kg | | 8137250 |

STAB-FIX 4 SQUARE SET

- 9 plastic parts within one set
- With transport bag

| | |
|-------------------------------------|---------|
| Stab-Fix 4 square 100 yellow | 3 pcs. |
| Stab-Fix 4 square 100 black | 6 pcs. |
| Bag 300 x 300 x 450 mm | 1 pcs. |
| Weight | 28.4 kg |
| Part no. | 8139342 |

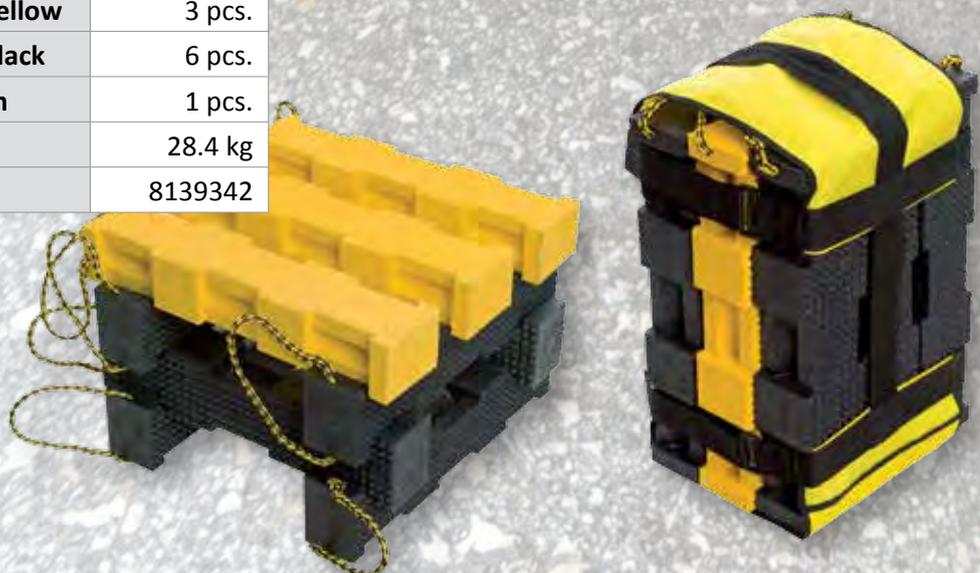

STANDARD MEETS EXTRA

Useful accessories for the rescue operation

Post protector with velco strips

Ideal supplement to the BASIC protective pads
Designed for modern vehicles and new rescue techniques

Material CORDURA 200
with 6 magnets each

Hydrophobic outside material
Inside is resistant against cuts
Washable

8 clips for easy installation
of the pads on the vehicles

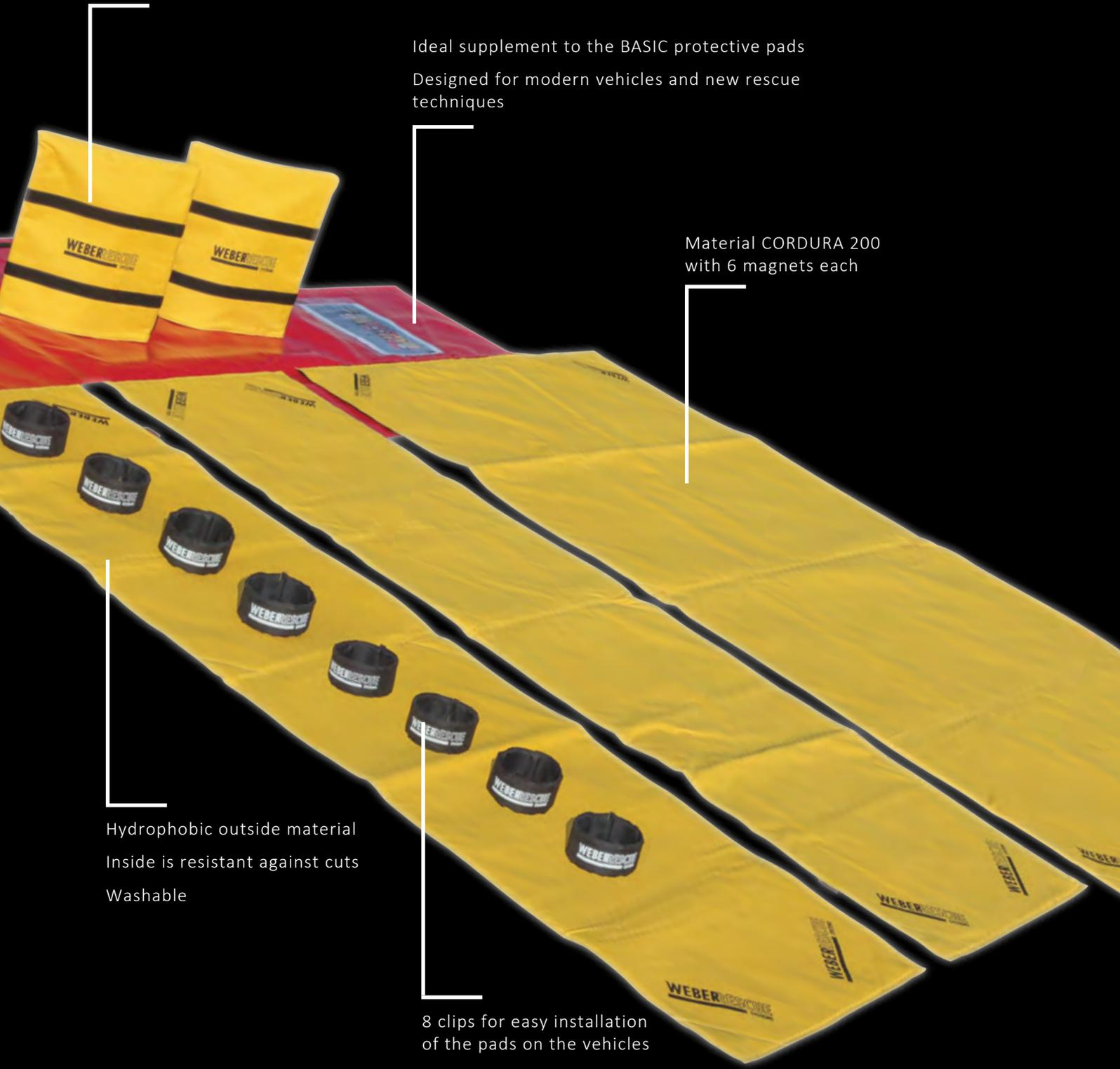

TIPS AND TRICKS

ROOF SECTIONING

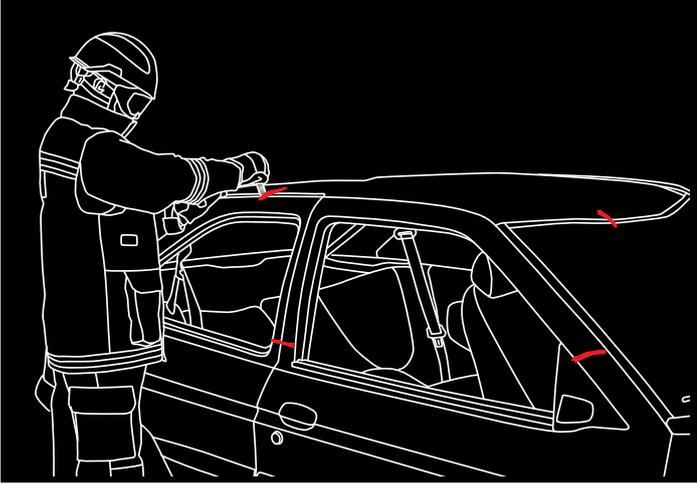
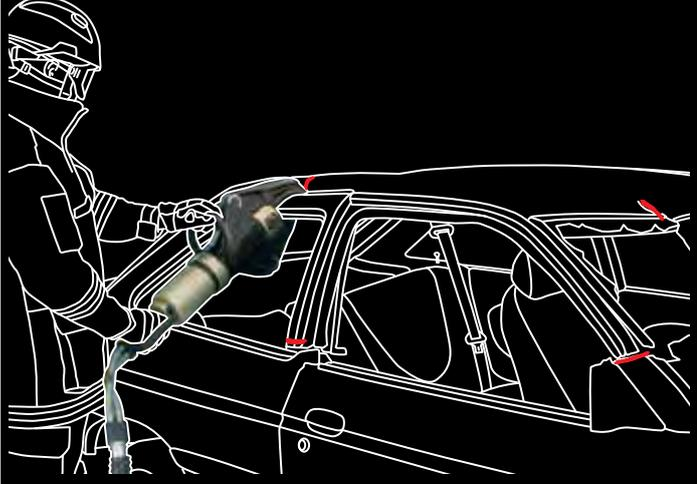
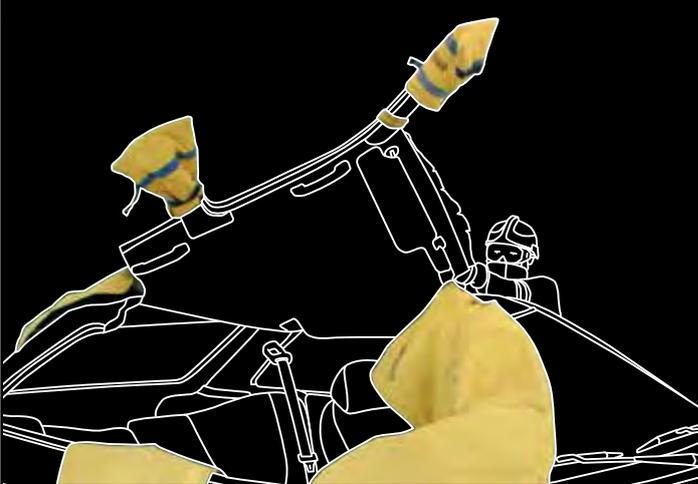
| | |
|--|--|
| <p>Mark cutting points</p> | <p>Remove glass between the cutting points</p> |
|  |  |
| <p>Cut at cutting points</p> | <p>Open roof</p> |
|  |  |





ACCESSORIES

GLASS-EX AND CENTRE PUNCH

- To remove laminated windscreens
- Including centre punch to remove safety glass

| | Weight | Part no. |
|-------------------|---------|----------|
| Glas-Ex | 1.5 kg | 8114161 |
| Centre punch | 0.06 kg | 8027676 |
| Replacement blade | | 8032858 |



GLASS MANAGEMENT

- Glass-Ex, centre punch and rescue knife
- Adhesive tape dispenser and protective goggles
- Two pieces rescue foil and prying tool
- In a case with foamed inlay

| | |
|------------|--------------------|
| Dimensions | 605 x 402 x 132 mm |
| Weight | 5.8 kg |
| Part no. | 1080917 |

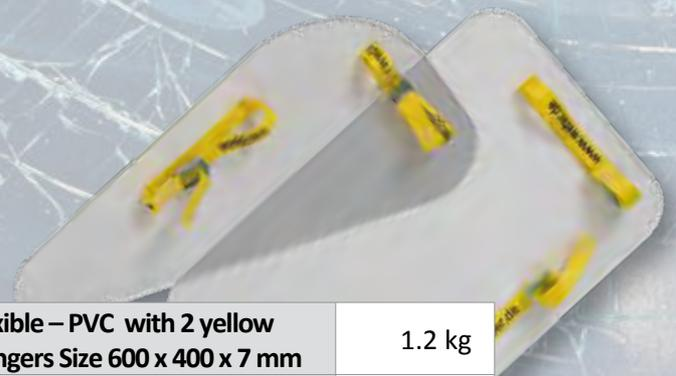

PROTECTION SHIELD

- Two different sizes and forms – multifunctional use
- Transparent and flexible

| | |
|--|---------|
| Triangle, flexible – PVC with 2 yellow grabbing hangers Size 600 x 400 x 7 mm | 1.2 kg |
| Rectangle, flexible – PVC with 3 yellow grabbing hangers Size 600 x 400 x 7 mm | 2.1 kg |
| Weight total | 3.3 kg |
| Part no. | 8136360 |



PATIENT PROTECTION PAD PAT-SAFE

- Flexible, see-through and robust patient protection
- Material CORDURA
- Removable window out of flexible Polyglas 0,3 mm
- With a transport bag

| | |
|---------------------------|------------------|
| Dimensions | 1,600 x 2,000 mm |
| Weight | 1.5 kg |
| Part no. | 1079078 |
| Replacement window | |
| Dimensions | 1,000 x 2,000 mm |
| Weight | 0.6 kg |
| Part no. | 1079079 |



ACCESSORIES

ROUGH EDGE PROTECTIVE PADS, ROUGH EDGE PROTECTIVE PADS UPGRADE AND PLUS



| Rough edge protective pads | | Rough edge protective pads UPGRADE | |
|--|-------------------|--|--------------------|
| Packing Dimensions | 700 x 500 x 95 mm | Packing Dimensions | 700 x 500 x 160 mm |
| 4 x column protection, with 2 hook-and-loop tape per pad | 300 x 350 mm | 2 x column protection, with 2 hook-and-loop tape per pad | 350 x 400 mm |
| 2 protection blankets, with 4 magnets per blanket | 650 x 650 mm | 2 protection blankets, with 4 magnets per blanket | 400 x 200 mm |
| 1 protection blanket, with 6 magnets | 1,650 x 650 mm | 1 protection blanket, with 6 magnets | 1,100 x 2,000 mm |
| Weight | 7.8 kg | Weight | 8.6 kg |
| Part no. | 8135517 | Part no. | 1078945 |

8 WEBER-Clips for fixation included!

| | |
|---|---------|
| Rough edge protective pads PLUS consisting of: | |
| Rough edge protective pads and rough edge protective pads UPGRADE | |
| Weight | 16.4 kg |
| Part no. | 1078947 |

WEBER-Clip individually

1078944

PATIENT STABILISATION SYSTEM PAT-STAB

Multi-useable

- Rescue blanket
- Respitor emergency kit
- Respitor emergency trousers
- Shaft rescue
- For stabilisation of patient in side position
- Special applications



| | |
|------------|----------------|
| Dimensions | 2,200 x 750 mm |
| Weight | 11.3 kg |
| Part no. | 1078942 |



ACCESSORIES

HALLIGAN TOOL

- Best accessory for technical rescue
- Available as metal cutter or prying tool
- Different sizes for flexible use
- Various applications
- Handle with nonslip surface

With prying head

| | | | |
|-----------------|--------------|--------------|----------------|
| Length | 30" - 762 mm | 36" - 914 mm | 42" - 1,066 mm |
| Weight | 5.5 kg | 5.8 kg | 5.9 kg |
| Part no. | 8053529 | 8053537 | 8053790 |

With metal cutting head

| | | |
|-----------------|--------------|--------------|
| Length | 30" - 762 mm | 36" - 914 mm |
| Weight | 5.0 kg | 5.7 kg |
| Part no. | 8052700 | 8052719 |

BASE SUPPORT AND SILL SUPPORT

- Ideal addition to rescue rams
- For supporting rescue ram in centre channel and on door sills
- Prevents slipping of the rescue ram

| | Weight | Part no. |
|---------------------------|---------------|-----------------|
| Base support front | 6.0 kg | 1824333 |
| Base support back | 9.8 kg | 1824341 |
| Sill support | 10.0 kg | 8121737 |

Base support back

Sill support

Base support front

ACCESSORIES

RESCUE PLATFORM

- Solid aluminium construction
- Adjustable ladders
- Safe adjustment with arresting bolts in 265 mm steps
- Rails equipped with extensions, individually adjustable in 30 mm steps
- Complies to DIN 14830

| | |
|---------------------------|------------------------|
| Packing dimensions | 1,050 x 1,790 x 280 mm |
| Weight | 51.0 kg |
| Part no. | 1057597 |



Find information about our Truck rescue training (TRT) on page 66

TRUCK CAGE SAFETY SYSTEM

- Ratchet with stitched-on lashing strap and eye-clamp
- Lashing strap length 10.0 m
- 2 rim clamps
- 2 x round sling length 3.0 m with 2.0 m hose
- Including suitcase

| | |
|-------------------|--------------------|
| Dimensions | 440 x 135 x 350 mm |
| Weight | 8.0 kg |
| Part no. | 8055416 |

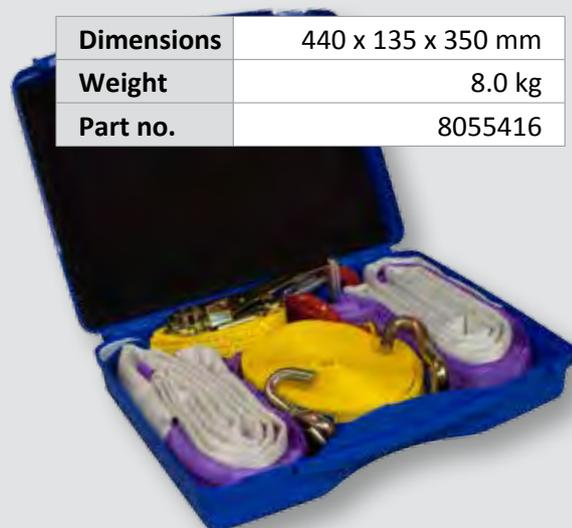

AIRBAG PROTECTION OCTOPUS

- Suitable for all types of cars and trucks
- Lightweight

| | |
|---|---------|
| Airbag protection cars driver side | |
| Weight | 1.7 kg |
| Part no. | 8046158 |
| Airbag protection cars passenger side in bag | |
| Weight | 3.8 kg |
| Part no. | 8046166 |
| Airbag protection trucks driver side in bag | |
| Weight | 0.8 kg |
| Part no. | 8046204 |



ACCESSORIES

RIM ADAPTERS

- Ideal addition to rescue rams to be used on lorries and buses
- With carrying case

| | Weight | Part no. |
|--------------------------------------|---------|----------|
| Rim adapters back wheel | 19.6 kg | 2852144 |
| Rim adapter set back and front wheel | 30.7 kg | 2854082 |

UNIVERSAL FASTENING FOR RESCUE TOOLS

- Individual fastening of rescue tools in the vehicle
- Can be fastened horizontally or vertically
- Space saving and flexible
- Rapid fastening

| Fastening for: | Weight | Part no. |
|--|--------|----------|
| Spreaders, cutters, combi tools | 2.7 kg | 1056401 |
| Rescue rams (except for RZT 3-1310 XL) | 2.9 kg | 1056402 |
| E-FORCE 2 tools | 3.5 kg | 1070296 |

HAND PUMP DPH 4018-SA

- Two-stage, can be used even when not in a horizontal position (up to a maximum inclination of 20°)
- Oil volume 2.5 l
- Complete with pair of hoses 5 m, with couplings, mounted on a wooden board
- Complies to DIN 14751

| | |
|----------|---------|
| Weight | 14.6 kg |
| Part no. | 1051174 |



ACCESSORIES

POWER WEDGE SPK 250

- Insertion height only 8 mm
- Creates initial opening for a pneumatic lifting bag
- Up to 58 mm lifting height
- Lifting force 25 to
- EN 13204 and NFPA 1936 tested
- Also available in E-FORCE 2-Version (page 39)



| | SPK 250 | SPK 250 E-FORCE 2 |
|----------|---------|-------------------------|
| Weight | 8.9 kg | 11.6 kg (incl. battery) |
| Part no. | 1822861 | 1077812 |

CRASH RECOVERY SYSTEM®

Comprehensive and up to date

- Database containing all mass-production series vehicles with airbags or alternative propulsion for cars, vans, light and heavy trucks as well as buses

Full information

- Consistent, easy to read vehicle graphics
- Information on all rescue relevant vehicle components
- Extensive background information, photos and disabling instructions

Saves time, increases safety

- No searching for components, know what's inside!
- Disabling instructions allow for a quick mitigation of hazards

Mobile, flexible, easy to use

- Available Microsoft Windows, Apple iOS (iPAD) and Android
- CRS license independent of operating system, OS can be changed later

Crash Recovery System® contains information about:

- Airbags and Airbag inflators, Seatbelt pretensioners and automatic roll bars
- Reinforcements, Batteries and fuel tanks
- Alternative propulsion components, such as high voltage batteries, gas tanks, disabling procedures
- Truck and bus components, such as chassis suspension, emergency exits, sleep cabins, lifting points

| ID-No. | Content and Licence |
|---------|---|
| 1052784 | Lite Edition for Windows, Apple iOS or Android (1 year license) <ul style="list-style-type: none"> • Databases for Europe, USA, UK and Pacific region • Graphics with all locations of safety components and danger zones • Manual vehicle selection • Monthly online updates for software and database maintenance |
| 8049335 | Standard Full Edition for Windows, Apple iOS or Android (1 year license) <ul style="list-style-type: none"> • Databases for Europe, USA, UK and Pacific region • Interactive graphics with single click access to all component information • Digital photos • Deactivation procedures for vehicles with alternative propulsion • Manual vehicle selection using make, model, bodystyle and model year • Monthly online updates for software and database maintenance |
| 8060169 | 1 year database subscription renewal |

USEFUL MEETS RESCUER

WEBER RESCUE s'series



TIPS AND TRICKS

SPOTTING AND MARKING OF DIFFICULT AREAS

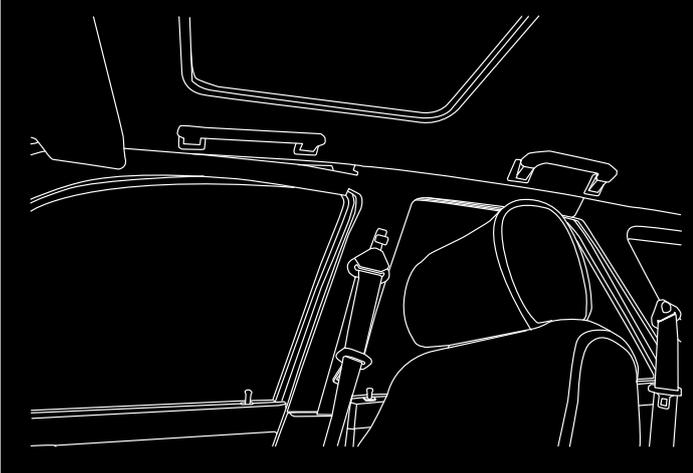
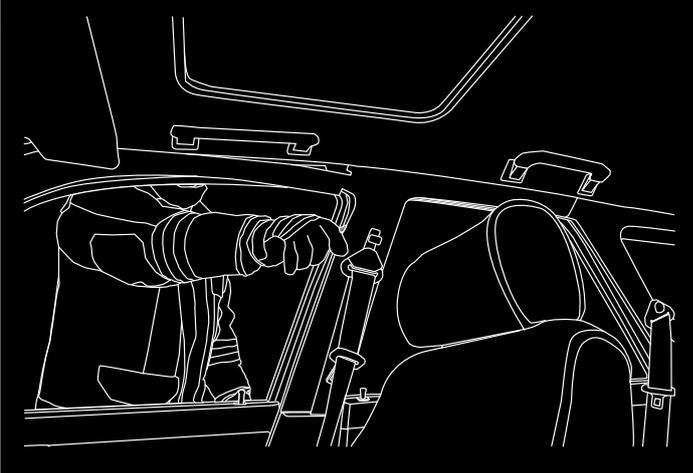
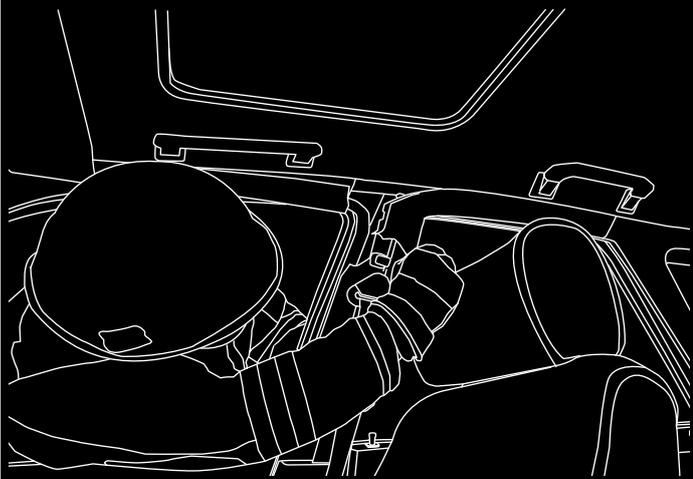
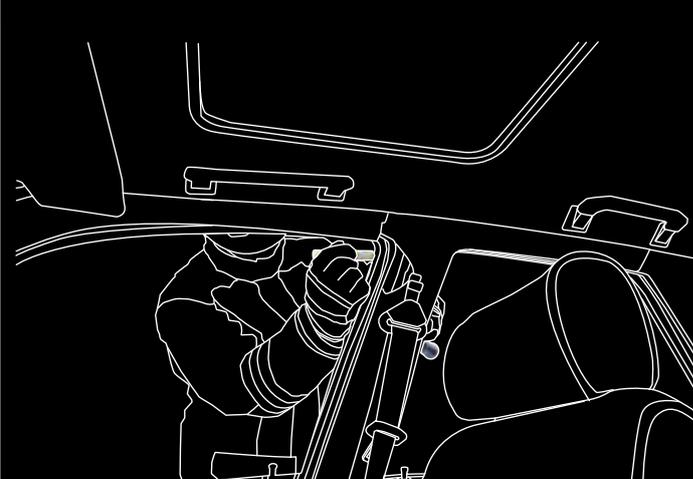
| | |
|--|--|
| <p>Where are the seat belt adjusters, inflators and strengthened parts, e.g. pipes</p> | <p>Lift the panel with the prying tool</p> |
|  |  |
| <p>Ascertain the problem</p> | <p>Mark the position with the rescue marker pen</p> |
|  |  |



S'SERIES

S'HEBERLE (PRYING TOOL)

- To remove the interior panel
- Airbag inflators or strengthend steel parts will be located easily
- Part no. 8053863

S'STIFTLER (RESCUE MARKER)

- Marking of cutting sides, spreading points and the base frame spots
- Top-dressing, permanent colour paste
- Photostable and smear-resistant

| | Part no. |
|-------------------|----------|
| s'Stiftler yellow | 8056501 |
| s'Stiftler red | 8056510 |

S'GURTSCHNEIDERLE (SEAT BELT CUTTER)

- For quick, easy and safe cutting of the seat belt
- Design of a cutter
- Part no. 1058692

S'BÄLLE (BALL)

- Two yellow balls, 70 mm diameter
- To fix the door handle and keep the door lock open
- In carrying bag with rope to be fastened at the waistbelt
- Part no. 1058691

S'BÜCHLE (BOOKLET)

- Pocket sized tips and tricks
- Everything worth to know on 92 pages
- Format DIN A6
- Part no. 1067550

S'MASSBÄNDLE (TAPE MEASURE)

- Quick and precise identification of the suitable rescue ram
- Part no. 1055707



S'SERIE

S'TÄSCHLE (TOOL BAG)

- Tool bag made of CORDURA®
- Clearly arranged and individual division
- No loss of mobility because of holster design
- Delivery without content

| | Part no. |
|------------------|----------|
| s'Täschle white | 1051517 |
| s'Täschle red | 1051518 |
| s'Täschle yellow | 1051519 |



S'SCHREIBPÄCKLE (TACTICAL WRITING SET)

- Adheres to any surfaces thanks to its electrostatic charge
- Flexible and easy to handle
- Part no. 1065542

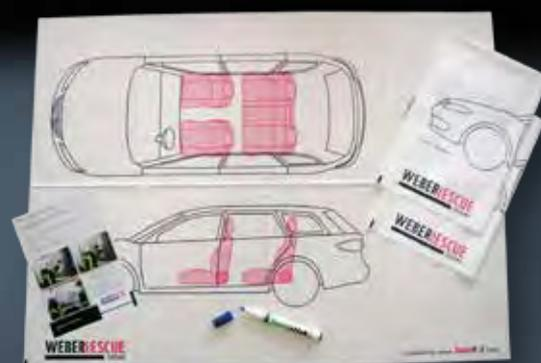

THL-PROTECTIVE GLOVES

- Kevlar/glass fibre lining and Kevlar gauntlet
- Protection class acc. to EN 388: 3, 5, 4, 3
- Pre-curved fingers, seamless finger tips
- Palm abrasion resistant and antiskid

| Size | Part no. |
|------|----------|
| 7 | 1067354 |
| 8 | 1067355 |
| 9 | 8055742 |
| 10 | 8055750 |
| 11 | 8055769 |
| 12 | 1067357 |



S'HANDSCHUHHALTERLE (GLOVE HOLDER)

- With velcro fastener and carabiner to hook into the waistbelt
- Part no. 8071250



S'TÜCHLE (BANDANA)

- Ideal to wear under the helmet
- To absorb sweat, washable
- Multi-use, universal size
- Part no. 8071268



DVD-SERIES

TECHNICAL RESCUE

| No. | Title | Part no. |
|-----|-----------------------------------|----------|
| 1 | Standard intervention rules - car | 8048126 |
| 2 | New car technologies | 8048134 |
| 3 | Medical rescue | 8048142 |
| 4 | Different rescue techniques | 8048150 |
| 5 | Natural gas and hybrid vehicles | 8048169 |
| 6 | Transporter and bus accidents | 8048177 |
| 7 | Truck rescue | 8048185 |

SCBA TRAINING

| No. | Title | Part no. |
|-----|---------------------------------|----------|
| 1 | Standard procedures | 8065039 |
| 2 | Flashover and nozzle techniques | 8065047 |
| 3 | Tactical ventilation | 8065055 |
| 4 | SAR systems | 8065063 |
| 5 | Thermal imaging camera | 8065071 |
| 6 | Emergency procedures | 8065080 |

TRAINING

RESCUE DAYS

- The worlds largest training event on technical rescue
- Takes place once a year in Germany (each year different locations)
- Appr. 800 participants form more than 20 different countries
- 80 international trainers (fire fighters and rescue services)
- Theory and practice
- Location 2016 Bad Kreuznach (Rheinland-Pfalz)

| Training Programme | Part no. |
|---|----------|
| RESCUE DAYS (2 days) | 8051550 |
| RESCUE DAY PLUS (1 day) | 3250060 |
| RESCUE DAY BUS (1 day) | 8055084 |
| RESCUE DAY COMPACT (1 day) | 8055092 |
| RESCUE DAY SYMPOSIUM (1 day) | 8069905 |

rescue DAYS





Edition 2016/2017B Subject to modification

WEBER-HYDRAULIK GMBH

Heilbronner Straße 30
74363 Güglingen/Deutschland
Telefon +49 (0) 7135/71-10270
Telefax +49 (0) 7135/71-10396
info@weber-rescue.com

Industriegebiet 3 + 4
4460 Losenstein/Österreich
Telefon +43 (0) 7255/6237-120
Telefax +43 (0) 7255/6237-12461
info@weber-rescue.com

WEBER RESCUE

SYSTEMS

www.weber-rescue.com